

# VIVA FITNESS

PUSH YOURSELF



**STAY STRONG  
STAY AHEAD**

**PRODUCT  
CATALOGUE  
2026**

[www.vivafitness.net](http://www.vivafitness.net)



'Thoughts become things' when you leave the realm of average thinking and follow your dreams by applying the right decision, driven by your mind. Fitness is a 'state of mind', which needs constant trigger to put ones thought into action.

Every action needs a reason for accomplishing it. Staying fit manifests in the physicality and inner well-being which everyone aspires. Every time you make a resolve and step-up your fitness goals, life gets the better of you and positive thoughts lead to positive outcomes.

VIVA Fitness is an accomplished brand in the world of fitness equipment, designed for both commercial and home use. It thrives on the belief that with the right set of tools, a fitter person is better off in accomplishing his personal and professional goals.



# INDEX

<b>TREADMILL</b>	<b>4-28</b>
<b>ELLIPTICAL TRAINER</b>	<b>29-43</b>
<b>RECUMBENT BIKE</b>	<b>44-48</b>
<b>UPRIGHT BIKE</b>	<b>49-53</b>
<b>AIR BIKE</b>	<b>54-55</b>
<b>GROUP BIKE</b>	<b>56-58</b>
<b>AIR ROWER &amp; SKI</b>	<b>59-63</b>
<b>INFINITY TRAINER &amp; TYRE FLIP</b>	<b>64</b>
<b>STEPMILL</b>	<b>65-67</b>
<b>GYM FAN</b>	<b>68</b>
<b>SIGNATURE SERIES (PC)</b>	<b>70-80</b>
<b>LEGACY SERIES (IP)</b>	<b>82-91</b>
<b>IT SERIES</b>	<b>92-103</b>
<b>BS SERIES</b>	<b>104-109</b>
<b>KG BLACK SERIES</b>	<b>110-118</b>
<b>SELECT LINE (BR)</b>	<b>120-125</b>
<b>PS SERIES</b>	<b>126-129</b>
<b>BH SERIES</b>	<b>130-138</b>
<b>E SERIES</b>	<b>140-157</b>
<b>SS SERIES</b>	<b>158-161</b>
<b>TITAN SERIES (TI)</b>	<b>162-165</b>
<b>PL SERIES</b>	<b>166-173</b>
<b>JPL SERIES</b>	<b>174-183</b>
<b>BEAST SERIES</b>	<b>184-187</b>
<b>FL SERIES</b>	<b>188-193</b>
<b>IF SERIES</b>	<b>194-195</b>
<b>GENERAL - EQUIPMENT</b>	<b>196-202</b>
<b>X SERIES</b>	<b>203-205</b>
<b>MULTI STATION GYMS</b>	<b>206-212</b>
<b>IMPULSE ZONE - GROUP TRAINING</b>	<b>213-214</b>
<b>WEIGHT LIFTING PLATFORM</b>	<b>215</b>
<b>FREE WEIGHT</b>	<b>216-218</b>
<b>BARBELLS / HANDLES /ACCESSORIES</b>	<b>219-226</b>
<b>SLED &amp; TYRE</b>	<b>227</b>

# VIRTUAL X

## COMMERCIAL TREADMILL



### SPECIFICATIONS

- **21.5" HD TFT Screen with different landscape programs.**
- **Supports Wi-Fi connection & web browsing.**
- AC driving system with adjustable variable frequency.
- 4.0 HP AC continuous (8.0 HP Peak) motor.
- 23" x 64" running surface.
- Speed : 1~20 kmph.
- Precise incline control from 0~15%.
- With intelligent inverter that detects speed variation and adjust automatically.
- Direct speed & incline keys on the console.
- Various motivating programs for different workout requirements.
- Extra heavy duty steel base with double cell neoprene rubber system for excellent suspension.
- 1" thick fibre board running deck.
- **With cordless mobile charger.**
- Heavy duty reliable 2 ply commercial grade German Siegling running belt.
- Large sized twin cup holder with a built-in tray.
- Emergency stop button.
- Sweat proof console design.
- Maximum User Weight : 180 Kgs.
- LXWXH : 223X95X160 CM.



# GENESIS 9i

## COMMERCIAL TREADMILL



INDICATOR LIGHT



REAL TIME HEART RATE MONITORING



ERGONOMICS SIDE STRIP



27 INCHES TOUCH SCREEN

### SPECIFICATIONS

- 27" capacitive touch screen with 1920x1080 HD resolution display.
- Supports Wi-Fi connection and web browsing.
- Durable AC motor driving system with over-current, short-circuit and comprehensive protection function
- 5.0 HP AC continuous (10.0 HP Peak) motor.
- 25" x 67" running surface.
- Speed : 1~25 kmph.
- Precise incline control from -3~18%.
- **Unique - 3% declinable deck.**
- Equipped with an automatic lubrication system.
- Direct speed & incline keys on the console.
- Built-in 24 motivating programs for different workout requirements.
- Extra heavy duty steel base with double cell neoprene rubber system for excellent suspension.
- 1" thick fibre board running deck.
- **With cordless mobile charger.**
- Heavy duty reliable 2 ply commercial grade German Siegling running belt.
- Large sized twin cup holder with a built-in tray.
- Emergency stop button.
- Sweat proof console design.
- Maximum User Weight : 200 Kgs.
- LXWXH : 221X98X176 CM.



# LEGACY i

## COMMERCIAL TREADMILL



### SPECIFICATIONS

- **23.8" HD TFT Screen with different landscape programs.**
- **Supports Wi-Fi connection & web browsing.**
- AC driving system with adjustable variable frequency.
- 5 HP AC continuous (10 HP Peak) external roto motor, high heat dissipation performance.
- 23" x 61" running surface.
- Speed 0.8-22kmph.
- Precise incline control from 0-18%.
- Including key-press, with direct speed (3/6/9/12) & incline(3/6/9/12) on the TFT screen.
- 36 programs : Fast Motion Mode (1), Classic Mode (3), Interval Mode (3), Custom Mode (12), Marathon Mode (4), Scenario Mode (3), Heart Rate Mode (3) & Fitness Test Mode(7).
- Programs developed by TOORX in collaboration with medical institutions in Italy & refined over a decade of use.
- Comes with unique curved upright tube and handle bar.
- With USB, audio port, speaker & regular lubrication & replacement reminder.
- **With wireless charger.**
- Bluetooth app with speaker & connectivity with Kinomap.
- Sweat proof console design.
- Large sized twin cup holder.
- Emergency stop button.
- Extra heavy duty running board supporting structure.
- Heavy duty reliable orthopaedic running belt.
- Durable and reliable aluminum side rails.
- With durable Japanese bearing in rollers.
- Maximum user weight : 200kg.
- LxWxH :206X90.5X155 CM.



# T6000

## COMMERCIAL TREADMILL



### SPECIFICATIONS

- AC driving system with adjustable variable frequency.
- 5.0 HP AC continuous (10 HP Peak) motor.
- 22.5" x 64" running surface.
- Speed 1~25 kmph.
- Precise incline control from 0~20%.
- 16 x 24 cm Dot Matrix & alpha numerical display showing time, speed, distance, incline, calories & heart rate
- Direct speed & incline keys on the console
- Various motivating programs for different workout requirements.
- Double phenolic heavy cushioned deck for excellent shock absorption that provides suitable push off to reduce the possibility of any type of injury to knees and joints.
- Heavy duty reliable orthopaedic running belt.
- Built in speakers
- Sweat proof console design.
- Two Cup / Mobile Holders.
- Maximum User Weight : 200 Kgs.
- LXWXH : 218X97X163 CM

### INNOVATIVE FEATURES



#### End cap & roller protect guide

- End cap installed with safety device for protection of user.



#### Safe key

- The emergency key with clip
- The user can also push center emergency button.



#### Grip

- Big, wide and smooth handle feel.
- Wide space structure so that user can work out freely and easily.
- Polyurethane sweat proof material.



#### Heart rate

- Intelligent heart rate system.
- Comfortable measure of heart rate.

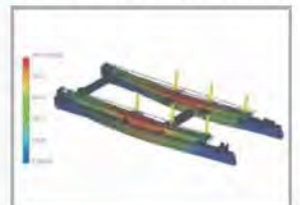

#### Frame

- Steady elevation system.
- Minimum noise system.
- Advance technology for stable and durable frame.



# T2222

## COMMERCIAL TREADMILL



### SPECIFICATIONS

- AC driving system with adjustable variable frequency.
- 4.0 HP AC continuous (8.0 HP Peak) motor.
- 21.5" x 62" running surface.
- Speed 1~25 kmph.
- Precise incline control from 0~15%.
- 7 LED display with dot matrix showing time, speed, distance, incline, calories, & heart rate.
- Direct speed & incline keys on the console.
- Various motivating programs for different workout requirements.
- Extra heavy duty steel base with double cell neoprene rubber system for excellent suspension.
- 1" thick fibre board running deck.
- Heavy duty reliable orthopaedic running belt.
- Large sized, twin cup holder with a built in tray to hold your mobile phone, MP3 and ipod.
- High speed O<sup>2</sup> generator.
- Emergency stop button.
- Sweat proof console design.
- Maximum user weight: 180 kg.
- LXWXH : 214X93X137 CM.



# Q9i

## COMMERCIAL TREADMILL



### SPECIFICATIONS

- **24" HD TFT Screen with different landscape programs.**
- **Supports Wi-Fi connection & web browsing.**
- AC driving system with adjustable variable frequency.
- 5 HP AC continuous (10 HP Peak) external roto motor, high heat dissipation performance.
- 25" x 66" running surface.
- Speed 0.5-25kmph.
- Precise incline control from 0-20%.
- Inducing key-press, with direct speed (3/6/9) & incline(3/6/9) on the TFT screen.
- 38 programs : HRC (4), custom (18), manual (1), target (3), fatburn (3), cardio (3), strength (5) & fat measuring program.
- Programs developed by TOORX in collaboration with medical institutions in Italy & refined over a decade of use.
- Comes with unique curved upright tube and handle bar.
- With USB, audio port, speaker & regular lubrication & replacement reminder.
- **With wireless charger.**
- Bluetooth app with speaker & connectivity with Kinomap.
- Sweat proof console design.
- Large sized twin cup holder.
- Emergency stop button.
- Extra heavy duty running board supporting structure.
- Heavy duty reliable orthopaedic running belt.
- Durable and reliable aluminum side rails.
- With durable Japanese bearing in rollers.
- Maximum user weight : 200kg.
- LXWXH : 226x97x167 CM.



# LEGACY

## COMMERCIAL TREADMILL



### SPECIFICATIONS

- AC driving system with adjustable variable frequency.
- 5 HP AC continuous (10 HP Peak) external roto motor, high heat dissipation performance.
- 23" x 61" running surface.
- Speed 0.8-22 kmph.
- Precise incline control from 0-18%.
- 23.8" LED+dot matrix display showing time, incline, speed, pace, calorie, distance, heart rate, step, METs, temperature etc.
- Medical grade silicon keys with direct speed (3/6/9/12) & incline (3/6/9/12) on the console.
- 44 programs : Fast Motion Mode(1), Manual Mode(1), Custom Mode(U1~U3), Distance Countdown Mode (1), Calorie Countdown Mode (1), Time Countdown Mode (1), P Mode(1~36) & fat measuring program.
- Programs developed by TOORX in collaboration with medical institutions in Italy & refined over a decade of use.
- Comes with unique curved upright tube and handle bar.
- With USB, audio port, speaker & regular lubrication & replacement reminder.
- Bluetooth app with Kinomap connectivity.
- Sweat proof console design.
- Large sized twin cup holder.
- Extra heavy duty running board supporting structure.
- Heavy duty reliable orthopaedic running belt.
- Durable and reliable aluminum side rails.
- With durable Japanese bearing in rollers.
- Maximum user weight : 200 kg.
- LXWXH :206X90.5X155 CM.



# GENESIS 9

## COMMERCIAL TREADMILL

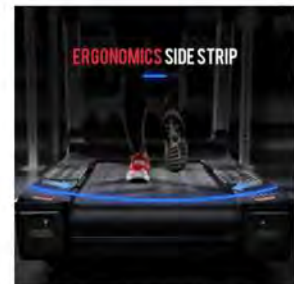

### SPECIFICATIONS

- 7 window bright LED display.
- Durable AC motor driving system with over-current, short-circuit and comprehensive protection function
- 5.0 HP AC continuous (10.0 HP Peak) motor.
- 25" x 67" running surface.
- Speed : 1~25 kmph.
- Precise incline control from -3~18%.
- **Unique - 3% declinable deck.**
- Equipped with an automatic lubrication system.
- Direct speed & incline keys on the console.
- Built-in 24 motivating programs for different workout requirements.
- Extra heavy duty steel base with double cell neoprene rubber system for excellent suspension.
- 1" thick fibre board running deck.
- **With cordless mobile charger.**
- Bluetooth app with Kinomap connectivity
- Heavy duty reliable 2 ply commercial grade German Siegling running belt.
- Large sized twin cup holder with a built-in tray.
- Emergency stop button.
- Sweat proof console design.
- Maximum User Weight : 200 Kgs.
- LXWXH : 221X98X176 CM.



# T3300

## COMMERCIAL TREADMILL



### SPECIFICATIONS

- AC driving system with adjustable variable frequency.
- 5.0 HP AC continuous (10.0 HP Peak) motor.
- 24" x 65" running surface.
- Speed 0.8~25 kmph.
- Precise incline control from -3~18%
- **Unique -3% declinable deck**
- 6 LED display with dot matrix showing time, speed, distance, incline, calories, heart rate, steps, pace & average speed .
- Direct speed & incline keys on the console.
- Various motivating programs for different workout requirements.
- Extra heavy duty steel base with double cell neoprene rubber system for excellent suspension.
- 1" thick fibre board running deck.
- Heavy duty reliable orthopaedic running belt.
- Large sized, twin cup holder with a built in tray to hold your mobile phone,
- With USB charging point.
- Bluetooth app with Kinomap connectivity
- High speed O<sup>2</sup> generator.
- Emergency stop button.
- Sweat proof console design.
- Maximum user weight: 180 kg.



# T2525

## COMMERCIAL TREADMILL



### SPECIFICATIONS

- AC driving system with adjustable variable frequency.
- 4.5 HP AC continuous (9.0 HP Peak) motor.
- 23" x 67" running surface.
- Speed 1~22 kmph.
- Precise incline control from 0~15%
- 7 LED display with dot matrix showing time, speed, distance, incline, calories, heart rate, steps.
- Comes with Aluminum strip on side rail
- Direct speed & incline keys on the console.
- Various motivating programs for different workout requirements.
- Extra heavy duty steel base with double cell neoprene rubber system for excellent suspension.
- 1" thick fibre board running deck.
- Heavy duty reliable orthopaedic running belt.
- Large sized, twin cup holder with a built in tray to hold your mobile phone.
- With USB charging point.
- MP3 connectivity with speakers.
- Emergency stop button.
- Sweat proof console design.
- Maximum user weight: 180 kg.
- LXWXH : 228X104X162 CM.



**Q9****COMMERCIAL TREADMILL****SPECIFICATIONS**

- AC driving system with adjustable variable frequency.
- 5 HP AC continuous (10 HP Peak) external roto motor, high heat dissipation performance.
- 24" x 65" running surface.
- Speed 0.5-25kmph.
- Precise incline control from 0-20%.
- 7LED+dot matrix display showing time, incline, speed, pace, calorie, distance, heart rate, step, METs, temperature etc.
- Medical grade silicon keys with direct speed (3/6/9) & incline (4/8/12) on the console.
- 38 programs : HRC (4), custom (18), manual (1), target (3), fatburn (3), cardio (3), strength (5) & fat measuring program.
- Programs developed by TOORX in collaboration with medical institutions in Italy & refined over a decade of use.
- Comes with unique curved upright tube and handle bar.
- With USB, audio port, speaker & regular lubrication & replacement reminder.
- Bluetooth app with Kinomap connectivity
- Sweat proof console design.
- Large sized twin cup holder.
- Extra heavy duty running board supporting structure.
- Heavy duty reliable orthopaedic running belt.
- Durable and reliable aluminum side rails.
- With durable Japanese bearing in rollers.
- Maximum user weight □200kg.
- LXWXH : 226×97×167 CM.



# Q7i

## COMMERCIAL TREADMILL



### SPECIFICATIONS

- **15.6" HD TFT Screen with different landscape programs.**
- **Supports Wi-Fi connection & web browsing.**
- AC driving system with adjustable variable frequency.
- 4.5 HP AC continuous (9.0 HP Peak) external roto motor, high heat dissipation performance.
- 24"x63" running surface.
- Speed 1-22kmph.
- Precise incline control from 0-15%.
- Including key-press, with direct speed (3/6/9) & incline (3/6/9) on the TFT screen.
- Various motivating programs for different workout requirements.
- With USB & audio interface.
- **With wireless charger.**
- Bluetooth app with speaker & connectivity with Kinomap
- Sweat proof console design.
- Large sized twin cup holder.
- Emergency stop button.
- Extra heavy duty running board supporting structure.
- Heavy duty reliable orthopaedic running belt.
- With durable Japanese bearing in rollers.
- Maximum user weight: 180kg.
- LXWXH : 210x93x161 CM.



# T1212

## COMMERCIAL TREADMILL



### SPECIFICATIONS

- AC driving system provides higher torque of power for heavy loading.
- 4.0 HP AC continuous (8.0 HP Peak) motor.
- 24.5" x 64" running surface.
- Speed 1–25 kmph.
- Precise incline control from 0~20%.
- Clear & luxurious design, 6 window LED display showing time, speed, incline, calories, distance, program & heart rate.
- Sweat proof console design / two cup / bottle holders / handle bar.
- Various motivating programs for different workout requirements.
- With BT music / BT App (including Fitshow & Zwift & Kinomap) / Wireless charging.
- The full-wrap side rails make the machine sturdier and more robust.
- Comes with stainless steel pedal on side rail.
- Heavy duty 3.7mm commercial use running belt.
- 25mm high-density running board.
- Maximum User Weight: 180 kgs.
- LXWXH : 238X104X162 CM.



# Q8

## COMMERCIAL TREADMILL



### SPECIFICATIONS

- AC driving system with adjustable variable frequency.
- 5 HP AC continuous (10.0 HP Peak) external roto motor, high heat dissipation performance.
- 24" x 65" running surface.
- Speed 0.5-25kmph.
- Precise incline control from 0-20%.
- 6 LED+dot matrix display showing time, incline, speed, pace, calorie, distance, heart rate, step, METs & temperature. Medical grade silicon keys with direct speed (3/6/9) & incline (4/8/12) on the console.
- Various motivating programs for different workout requirements.
- With USB & audio interface, USB can be used for charging.
- Bluetooth app with Kinomap connectivity.
- Sweat proof console design.
- Large sized twin cup holder.
- Emergency stop button.
- Extra heavy duty running board supporting structure.
- Heavy duty reliable orthopaedic running belt.
- With durable Japanese bearing in rollers.
- Maximum user weight :180kg.
- LXWXH:226x97x167 CM.



# Q5i

## COMMERCIAL TREADMILL



### SPECIFICATIONS

- **15.6" HD TFT Screen with different landscape programs.**
- **Supports Wi-Fi connection & web browsing.**
- AC driving system with adjustable variable frequency
- 4.0 HP AC continuous (8.0 HP Peak) external rotor motor, high heat dissipation performance
- 23.6"x 63"(60\*160cm) running surface
- Speed 1-22kmph
- Precise incline control from 0-15%
- Including key-press, with direct speed (3/6/9) & incline (3/6/9) on the TFT screen
- Various motivating programs for different workout requirements: quick start/ real scene mode (6) / target mode (3) / training mode (5) / HRC mode
- With USB & audio interface
- **With wireless charger**
- Bluetooth app with speaker & connectivity with Kinomap
- Sweat proof console design
- Large sized, twin cup holder to hold your mobile phone
- Emergency stop button
- Extra heavy duty running board supporting structure
- Heavy duty reliable orthopaedic running belt
- Maximum user weight : 180kg
- L X W X H : 210x93x161 cm



# X10

## COMMERCIAL TREADMILL



### SPECIFICATIONS

- AC driving system with adjustable variable frequency.
- 4.0 HP AC continuous (8.0 HP Peak) motor.
- 23" x 62" running surface.
- Speed 0.8~20 kmph.
- Precise incline control from 0~18%
- With cordless mobile charger.
- Bluetooth app with Kinomap connectivity.
- 5 LED display with dot matrix showing time, speed, distance, incline, calories, heart rate, steps, pace & average speed .
- Direct speed & incline keys on the console.
- Various motivating programs for different workout requirements.
- Extra heavy duty steel base with double cell neoprene rubber system for excellent suspension.
- 1" thick fibre board running deck.
- Heavy duty reliable orthopaedic running belt.
- Large sized, twin cup holder with a built in tray to hold your mobile phone.
- With USB charging point.
- High speed O<sup>2</sup> generator.
- Emergency stop button.
- Sweat proof console design.
- Maximum user weight: 160 kg.
- L X W X H : 209 X 88 X 163 CM



# T3000

## COMMERCIAL TREADMILL



### SPECIFICATIONS

- AC driving system provides higher torque of power for heavy loading
- 4.0 HP AC continuous (8.0 HP Peak) motor
- 23.5" x 61" running surface
- Speed 1~20 kmph
- Precise incline control from 0~20%
- Clear & luxurious design, 6 window LED display showing time, speed, incline, calories, distance, program & heart rate
- Various motivating programs for different workout requirements
- Double shock absorption that provides suitable push off to reduce the possibility of injury to knees and joints
- Comes with Aluminum strip on side rail
- Heavy duty 2.5mm reliable orthopedic running belt
- Sweat proof console design
- Two cup / bottle holders
- Maximum User Weight:180 kgs
- LXWXH : 190X96X165 CM.



# Q7

## COMMERCIAL TREADMILL



### SPECIFICATIONS

- AC driving system with adjustable variable frequency.
- 4.5 HP AC continuous (9.0 HP Peak) external roto motor, high heat dissipation performance.
- 24" x 63" running surface.
- Speed 1-22kmph.
- Precise incline control from 0-15%.
- 7 LED+dot matrix display showing time, incline, speed, pace, calorie, distance, heart rate, step, METs & temperature.
- Medical grade silicon keys with direct speed (3/6/9) & incline (4/8/12) on the console.
- Various motivating programs for different workout requirements.
- With USB & audio interface, USB can be used for charging.
- Bluetooth app with Kinomap connectivity
- Sweat proof console design.
- Large sized twin cup holder.
- Emergency stop button.
- Extra heavy duty running board supporting structure.
- Heavy duty reliable orthopaedic running belt.
- With durable Japanese bearing in rollers.
- Maximum user weight: 180kg.
- LXWXH: 210x93x161 CM.



# Q3i

## COMMERCIAL TREADMILL



### SPECIFICATIONS

- **15.6" HD TFT Screen with different landscape programs.**
- **Supports Wi-Fi connection & web browsing.**
- AC driving system with adjustable variable frequency
- 3.0HP AC continuous (6.0HP Peak) external roto motor with high hear performance
- 22.44" x 59" running surface
- Speed:1-20km/h
- Precise incline control from 0-15%
- Inducing key-press, with direct speed (3/6/9) & incline (3/6/9) on the TFT screen
- Various motivating programs for different workout requirements: quick start/ real scene mode (6) / target mode (3) / training mode (5) / HRC mode
- With USB & audio interface
- **With wireless charger**
- Bluetooth app with speaker & connectivity with Kinomap
- Sweat proof console design
- Large sized, twin cup holder to hold your mobile phone
- Emergency stop button
- Extra heavy duty running board supporting structure
- Durable Japanese bearing used in roller
- Max user weight:150kg
- L x W x H : 197x93x145 cm



# X8

## COMMERCIAL TREADMILL



### SPECIFICATIONS

- AC driving system with adjustable variable frequency.
- 4.0 HP AC continuous (8.0 HP Peak) motor.
- Speed : 1~20 kmph.
- Precise incline control from 0 ~15%.
- 21" x 58" running surface.
- Multi window display showing time, speed, distance, incline, calories & heart rate.
- Direct speed & incline keys on the console.
- Various motivating programs for different workout requirements.
- Double phenolic heavy cushioned deck for excellent shock absorption that provides suitable push off to reduce the possibility of any type of injury to knees and joints.
- Heavy duty reliable orthopedic running belt.
- Emergency stop button.
- Sweat proof console design.
- Two Mobile/Bottle Holders.
- Maximum User Weight : 150 Kgs.
- LXWXH : 216X92X151 CM.



# Q5

## COMMERCIAL TREADMILL



### SPECIFICATIONS

- AC driving system with adjustable variable frequency.
- 4.0 HP AC continuous (8.0 HP Peak) external roto motor with high heat performance.
- 23.6" x 63" running surface.
- Speed : 1-22 kmph.
- Precise incline control from 0-15%.
- 6 LED+dot matrix display showing time, incline, calorie, distance and heart rate.
- Medical grade silicon keys with direct speed (3/6/9) & incline (4/8/12) on the console.
- Various motivating programs for different workout requirements: HRC, custom, manual, hill, fat burn, target, cardio, strength, fit test etc.
- Bluetooth app with Kinomap connectivity
- Sweat proof console design.
- Large sized, twin cup holder with a built-in tray to hold your mobile phone / tablet.
- Emergency stop button.
- Extra heavy duty running board supporting structure.
- Heavy duty reliable orthopaedic running belt.
- Maximum user weight: 180kg.
- LXWXH: 210×93×161 CM.



# Q3

## LIGHT COMMERCIAL TREADMILL



### SPECIFICATIONS

- AC driving system with adjustable variable frequency.
- 3.0HP AC continuous (6.0HP Peak) external roto motor with high hear performance.
- 22.44" x 59" running surface.
- Speed:1-20km/h.
- Precise incline control from 0-15%.
- 5 LED+dot matrix display showing time, incline, speed, calorie, distance, heart rate and step.
- Medical grade silicon keys with direct speed (3/6/9) & I ncline(4/8/12) on the console.
- Various motivating programs for different workout requirements: 4HRC, 18 preset, 1 manual, 1 fit test.
- Sweat proof console design.
- Large sized, twin cup holder with a built in tray to hold your mobile phone & tablet PC.
- Bluetooth app with Kinomap connectivity
- Emergency stop button.
- Extra heavy duty running board supporting structure.
- Durable Japanese bearing used in roller.
- Max user weight : 150 kg.
- L X W X H : 197x93x145cm.



# T6666

## CURVEMILL



### SPECIFICATIONS

- Innovative curved deck with durable rubber belt having aluminum base.
- Non motorized technology.
- Comes with detachable waist strap that allows variety of pulling & pushing exercise.
- Display showing : distance, time, speed, pulse, calories & body fat.
- Exercise description : run, power walk, lateral shuffle & low push.
- With 6 resistance levels.
- Highly durable treadmill with low maintenance cost.
- Ideal for core strength & interval training.
- Long hand rails for maximum safety.
- 195 kgs heavy duty stable steel structure.
- Noise below 80 DB.
- Maximum user weight 200 kg.
- LXWXH : 202X96X151 CM.



**MANUAL**

**LCD**

# T6262

## CURVEMILL



### SPECIFICATIONS

- Innovative curved deck with durable nylon belt.
- Non motorized technology.
- Display showing : distance, time, speed, pulse, calories & body fat.
- Exercise description : run, power walk, lateral shuffle & low push.
- With 6 resistance levels.
- Highly durable treadmill with low maintenance cost.
- Ideal for core strength & interval training.
- Long hand rails for maximum safety.
- Maximum user weight 150 kg.
- LXWXH : 200X90X153 CM.



**MANUAL**

**LCD**

# T007

## INCLINE TRAINER



### SPECIFICATIONS

- Unique patented Decline to Incline running deck -0.5 ~ 40%.
- Ideal for special training of army, professional sports etc.
- AC driving system with adjustable variable frequency.
- 3.0 HP AC continuous (6.0 HP Peak) motor.
- Speed : 1~20 kmph.
- 21.5" x 61" running surface.
- 7" large window LED display showing time, speed, distance, incline, calories, heart rate etc.
- MP3 connectivity with speakers.
- Various motivating programs for different workout requirements.
- High speed O<sup>2</sup> generator.
- Heavy duty reliable orthopedic running belt.
- Emergency stop button.
- Sweat proof console design.
- Two Mobile/Bottle Holders.
- Maximum User Weight : 150 Kgs.
- LXWXH : 179X112X202 CM



# KH6050

## FULL BODY TRAINER

CLIMBING STRIDE



ELLIPTICAL STRIDE



RUNNING STRIDE



### SPECIFICATIONS

- New patented technology that offers user to choose between Climbing/Elliptical/Running/Bike stride
- LED dot matrix showing time, speed, distance, calories, RPM, pulse, watt & resistance
- Various motivating programs for different workout requirements
- Multi grip handle bar
- Variable stride length from 28" to 38" accommodating users of different heights
- Large pedals with toe caps for extra comfort
- Resistance Level : 0-16
- Reinforced frame for extra strength
- The large drink & accessories shelf is conveniently located with easy access while working out
- Maximum User Weight : 180 kgs
- LXWXH : 203X108X174 CM.



# E1000

## COMMERCIAL ELLIPTICAL TRAINER



### SPECIFICATIONS

- Resistance : Magnetron resistance system.
- Power : Self-generation.
- Display : 4 window LED with easy to use control panel.
- Resistance level : 40 levels.
- Program : Constant Watt, Interval, Fat burn, Cardio etc.
- Flywheel : 14kg.
- Maximum User Weight : 180 kgs.
- LXWXH : 176X92X116 CM.



# KH3060

## COMMERCIAL ELLIPTICAL TRAINER



### SPECIFICATIONS

#### DRIVE

- Rear-drive and handle arms enable sustain, smooth and engaging exercise, regardless your fitness level.
- Ergonomic multi position dual action handle bars.
- Large and impact-absorbing pedals (**with cushioned gel pads**) provide gentle movement to reduce lower back stress.
- Self- powered system, low maintenance design and space-saving deliver a fast return of investment.
- Power : Generator.
- Resistance level : 20

#### MONITOR

- Heart rate control programs provide user a challenging training.
- Multi readout summarizes workout result every minute, displays time used, distance covered, burned calories, watt and mets achieved.
- Reliable sweat-proof construction keeps console in demanding commercial environment.

#### SPECIAL FEATURES

- Offers various motivating programs for different workout requirements.
- Large LED's and intuitive keystroke permit easy-to-operation interface for change and monitor.
- Quick start key allows commencing exercise with a touch of button.
- Display function is switchable for feedback of Level, Watt, Mets and Pulse.
- Cup holder with towel handle.
- Maximum user weight : 180 kg.
- LXWXH : 218X74X161 CM.



# E900i

## COMMERCIAL ELLIPTICAL TRAINER



### SPECIFICATIONS

- Display : 15.6" TFT touch screen.
- Supports Wi-Fi connection & web browsing.
- Resistance level : 32 levels.
- Program : Various motivating programs for different workout requirements.
- 14.2kg two ways flywheel with 20" stride length & 3 pcs crank arm.
- Comes with Blue tooth connectivity, Speakers & Mobile phone holder.
- Maximum User Weight : 160 kgs.
- LXWXH : 190X86X177 CM.



# AIR GLIDE 700+

## COMMERCIAL ELLIPTICAL TRAINER



### SPECIFICATIONS

- LED dot matrix console readouts: INCLINE, TIME, DISTANCE, CALORIES, PULSE, SPEED / RPM, LEVEL, WATT, RECOVERY etc.
- Various motivating programs for different workout requirements.
- Level Control : 32 resistance levels.
- Inclination : 10-34°.
- 51cm unique stride length.
- 14 kgs flywheel.
- Both forward & reverse motions offer various workout options.
- Hand held pulse sensors enable to monitor the heart rate all times.
- Mp3 with speaker and USB charger.
- Unique durable floor levelers on front & rear stabilizer.
- With adaptor power system.
- Maximum user weight : 180 kg
- LXWXH : 215X75X170 CM.



# E700i

## COMMERCIAL ELLIPTICAL TRAINER



- SPECIFICATIONS**
- Display : 15.6" TFT touch screen.
  - Supports Wi-Fi connection & web browsing.
  - Resistance level : 40 levels.
  - Program : 12 Preset, Manual, Interval, Weight loss, Target heart rate, Random, Warm up & down.
  - 10kg two ways flywheel with 22" stride length & 3 pcs crank arm.
  - Comes with Earphone port, Speakers & Mobile phone holder.
  - Maximum User Weight : 160 kgs.
  - LXWXH : 165X53X80 CM.



# E900

## COMMERCIAL ELLIPTICAL TRAINER



### SPECIFICATIONS

- Resistance : Magnetron resistance system.
- Display : 5 window LED dot matrix.
- Self power generating.
- Resistance level : 32 levels.
- Various motivating programs for different workout requirements.
- 14.2kg two ways flywheel with 20" stride length & 3 pcs crank arm.
- Comes with Mobile phone holder & Transport wheels.
- Maximum User Weight : 160 kgs.
- LXWXH : 190X85X176 CM.



# E600

## COMMERCIAL ELLIPTICAL TRAINER



### SPECIFICATIONS

- LED dot matrix console readouts: INCLINE, TIME, DISTANCE, CALORIES, PULSE, SPEED / RPM, LEVEL, WATT, FAN etc.
- Various motivating programs for different workout requirements.
- Level Control : 20 resistance levels.
- With 15 level power incline.
- 500mm x 220mm unique stride length.
- 12 kgs flywheel.
- Both forward & reverse motions offer various workout options.
- Hand held pulse sensors enable to monitor the heart rate all times.
- Mp3 with speaker and USB charger.
- With O2 generator and bottle holder.
- Unique durable floor levelers on front & rear stabilizer.
- With adaptor power system.
- Maximum user weight : 150 kg
- LXWXH : 215X77X194 CM.



# E800

## COMMERCIAL ELLIPTICAL TRAINER



### SPECIFICATIONS

- Rear drive and dual handle arms enable smooth and engaging exercise, regardless of your fitness level.
- Self-powered system.
- LED screen.
- 8 Defaulted programs + 2 customized programs.
- Stride distance : 500mm.
- Resistance level : 26 levels.
- Max user weight : 150KGS.
- LXWXH : 209X78X168 cm.



# KH620

## COMMERCIAL ELLIPTICAL TRAINER



### SPECIFICATIONS

- 20" long stride.
  - Red backlight LED display.
  - Readouts: Time, speed, distance, calories, pulse, watt, program, bodyfat (height/weight/age) and level.
  - Multiple programs including 1 Manual, 4 HRC, 1 Watt, 20 preset, 4 Users and 3 Fitness test.
  - 3 pcs crank system with 14kgs flywheels.
  - USB port with MP3 reader.
  - Handheld pulse sensor.
  - Magnetic flywheel.
  - With self generating system.
  - Resistance level - 24.
  - Transport wheels.
  - Adjustable floor levelers.
- Maximum User Weight: 150kgs.



# E200

## COMMERCIAL ELLIPTICAL TRAINER



### SPECIFICATIONS

- LED dot matrix console readouts: TIME, DISTANCE, CALORIES, PULSE, SPEED / RPM, LEVEL, WATT, FAN etc.
- Various motivating programs for different workout requirements.
- Level Control : 24 resistance levels.
- Dual Technology - resistance with both magnetic and air.
- 520mm x 240mm unique stride length.
- 8 kgs flywheel.
- Both forward & reverse motions offer various workout options.
- Hand held pulse sensors enable to monitor the heart rate all times.
- With ipad holder & bottle cage.
- Unique durable floor levelers on front & rear stabilizer.
- Transport wheels on the front stabilizer, providing easy movement to move the items.
- With adaptor power system.
- Maximum user weight : 150 kg.
- LXWXH : 162X65X180 CM.



# KH640

## COMMERCIAL ELLIPTICAL TRAINER



### SPECIFICATIONS

- Display : 5 window LED dot matrix.
- Self power generating.
- Resistance level : 40 levels.
- Program : 12 Preset, Manual, Interval, Weight loss, Target heart rate, Random, Warm up & down.
- 14.2kg two ways flywheel with 19" stride length & 3 pcs crank arm.
- Comes with Mobile phone holder & Transport wheels.
- Maximum User Weight : 160 kgs.
- LXWXH : 200X81X166 CM.



# KH585

## COMMERCIAL ELLIPTICAL TRAINER



### SPECIFICATIONS

#### Drive

- Rear Drive and handle arms enable sustain, smooth and engaging exercise, regardless your fitness level.
- Ergonomic multi position dual action handle bars.
- Large & impact-absorbing pedals (with gel pads) provide gentle movement to reduce lower back stress.
- Self-powered system, low maintenance design & space-saving deliver a fast return of investment.
- Power : Generator.
- Resistance level : 16.

#### Monitor

- Heart rate control programs provide user a challenging training.
- Multi readout summarizes workout result every minute, displays time used, distance covered, burned calories, watt and meters achieved.

#### Special Features

- Offers various motivating programs for different workout requirements.
- Large LED's and intuitive keystroke permit easy to operate interface for change and monitor.
- Quick start key allows commencing exercise with a touch of a button.
- Display function is switchable for feedback of Level, Watt, Meters and Pulse.
- Cup holder with towel handle.
- Max User Weight :150Kgs.
- LxWxH : 210x64x180 cm.



## KH610

### LIGHT COMMERCIAL ELLIPTICAL TRAINER



#### SPECIFICATIONS

- 20" long stride.
- 3 section manual incline.
- Blue backlight LCD display.
- Readouts: Time, speed, distance, calories, pulse, watt, program, bodyfat (height/weight/age) and level.
- Multiple programs including 1 Manual, 4 HRC, 1 Watt, 11 preset, 4 Users and 3 Fitness test.
- Handheld pulse sensor.
- Magnetic flywheel.
- With adapter power system.
- Resistance level - 24.
- Transport wheels.
- Adjustable floor levelers.
- Maximum User Weight: 130kgs.
- LXWXH : 176X68X179 CM

## KH690

### LIGHT COMMERCIAL ELLIPTICAL TRAINER



#### SPECIFICATIONS

##### Drive

- Pull Motor System with poly V-belt.
- Resistance system : New Technology silent programmable magnetic resistance system.
- Resistance level : 32 levels.
- With adaptor power system.

##### Monitor

- Advance LCD display.
- Display readouts : Time, Distance, Speed, Level, Calories, Pulse & Watts.
- 10 programs.

##### Special Features

- With 4 level manual incline.
- Adjustable stride for ultimate workout.
- Both forward and reverse motions offer various workout options.
- Heavy -gauge, epoxy hybrid, steel frame.
- Low impact workout.
- Long stride & 9 kg of rotating flywheel ensures smooth & dynamic elliptical movement.
- Comfy over-sized, non-slip pedals.
- Handheld pulse sensors.
- Dual action handle bars with high density foam grips.
- Accessory tray & built-in reading rack.
- Transport wheels.
- Zwiift support.
- Bluetooth support.
- Adjustable floor levelers.
- Maximum User Weight : 150 Kgs.
- LXWXH : 165X63X170 CM.

## KH965

### LIGHT COMMERCIAL ELLIPTICAL TRAINER



#### SPECIFICATIONS

- 20" long stride length with 2 levels of adjustment.
- Adjustable swing bar.
- Display readouts : Time, Distance, RPM, Speed, Calories, Pulse, Body Ratio, BMI, BMR and Temperature.
- Various motivating programs for different workout requirements.
- Handheld pulse sensor.
- 10kgs flywheel.
- 15 level Magnetic resistance system.
- Transport wheels.
- Adjustable floor levelers.
- Maximum User Weight : 135 Kgs.

## KH960

### LIGHT COMMERCIAL ELLIPTICAL TRAINER



#### SPECIFICATIONS

- 20" long stride length with 2 levels of adjustment.
- Adjustable swing bar.
- Display readouts : Time, Distance, RPM, Speed, Calories, Pulse, Body ratio, BMI, BMR and Temperature.
- Handheld pulse sensor.
- 10 kgs fly wheel.
- Magnetic 8 level manual tension control system.
- Transport wheels.
- Adjustable floor levelers.
- Maximum User Weight : 130 Kgs.

# R900i

## COMMERCIAL RECUMBENT BIKE



### SPECIFICATIONS

- Display : 15.6" TFT touch screen.
- Supports Wi-Fi connection & web browsing.
- Resistance level : 32 levels.
- Program : Various motivating programs for different workout requirements.
- Ergonomic multi grip handles with heart rate & resistance control keys.
- Weighted pedals provide gentle movement to reduce lower back stress.
- Cushioned seats with horizontal adjustment.
- Comes with Blue tooth connectivity, Speakers & Mobile phone holder.
- Maximum User Weight : 160 kgs.
- LXWXH : 166X66X132 CM.



# KH3040

## COMMERCIAL RECUMBENT BIKE



### SPECIFICATIONS

#### DRIVE

- Two stage drive with poly V-belt.
- Resistance System : Self powered hybrid brake.
- Resistance Level : 20 Levels.

#### MONITOR

- 7 window dot matrix LED display.
- Display readouts : Time, Distance, RPM, Speed, Level, Calories, Pulse and Watts.
- Various motivating programs for different workout requirements.

#### SPECIAL FEATURES

- The easy-to-operate adjustment bar to move the seat forward and backward.
- Walk-through design to get on / off easily.
- Accessory tray with cup holder.
- Seat handle bars with quick access resistance (+/-) keys and handheld pulse sensors.
- Adjustable pedal straps
- Aluminum upright beam
- Hidden 3 piece cranks inside crank cover for safety
- Transport wheels
- Adjustable floor levelers
- Built-in receiver
- Maximum User Weight : 180 kgs
- LXWXH : 165X64X138 CM.

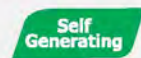

# R900

## COMMERCIAL RECUMBENT BIKE



### SPECIFICATIONS

- 5 window LED display with dot matrix showing time, speed, distance, calories, pace, heart rate etc.
- Offers various motivating programs for different workout requirements.
- Ergonomic multi grip handles with heart rate & resistance control keys.
- Weighted pedals provide gentle movement to reduce lower back stress.
- Power: Self Generator.
- Cushioned seats with horizontal adjustment.
- Low maintenance and space-saving design.
- Resistance level : 32
- Large sized cup holder.
- Maximum user weight: 160 kg.
- LXWXH : 166X66X132 CM.



# KH619

## COMMERCIAL RECUMBENT BIKE



### SPECIFICATIONS

#### Drive

- One stage drive with poly V-belt.
- Resistance System : Self powered generator brake.
- Resistance Level : 32 Levels.

#### Monitor

- LED(red light).
- Display readouts : speed,time,distance,calorie,heart rate,level,wat.
- 20 programs : 1 manual, 11 presetting , 4 HRC , 3 fittest, 1 wat.

#### Special Features

- The easy-to-operate adjustment to move the seat forward and backward.
- Walk-through design to get on / off easily.
- Seat handle bars with handheld pulse sensors.
- Adjustable pedal straps.
- 3 piece crank.
- Built-in speakers & Bluetooth Music.
- With IP support bracket.
- Transport wheels.
- Adjustable floor levelers.
- Maximum User Weight: 180 kgs.



# KH850

## COMMERCIAL RECUMBENT BIKE

### SPECIFICATIONS

- Control System: PMS intelligent electric resistance
- Heart Rate: hand-held heart rate
- Screen Display: 5-window high-brightness white light LED display
- Sports Program: built-in program 30P mode, HRC mode x 3 & WATT mode
- Resistance adjustment: 32 levels
- Seat with adjustable front & back movement
- Flywheel weight: 9KG two-way magnetic control wheel
- Transmission method: belt
- Motion trajectory: fixed elliptical motion trajectory
- With USB charging function, Bluetooth music input function.
- Maximum User Weight : 150kgs
- LxWxH : 159x72x136 cms



# KH575

## COMMERCIAL RECUMBENT BIKE

### SPECIFICATIONS

#### Drive

- Two stage drive with poly V-belt.
- Resistance System : Self powered hybrid brake
- Resistance Level : 16.

#### Monitor

- 7 window dot matrix LED display
- Display readouts : Time, Distance, Speed, Level, Calories, Pulse and Watts
- Various motivating programs for different workout requirements

#### Special Features

- The easy-to-operate adjustment bar to move the seat forward and backward
- Walk-through design to get on / off easily
- Adjustable resistance levels
- Aluminum upright beam
- Hidden 3 piece cranks inside crank cover for safety
- Transport wheels
- With easy moving wheels
- Built-in receiver
- Maximum User Weight : 150kgs
- LxWxH : 183x68x90 cms



# U900i

## COMMERCIAL UPRIGHT BIKE



### SPECIFICATIONS

- Display : 15.6" TFT touch screen.
- Supports Wi-Fi connection & web browsing.
- Resistance level : 32 levels.
- Program : Various motivating programs for different workout requirements.
- Ergonomic multi grip handles with heart rate & resistance control keys.
- Weighted pedals provide gentle movement to reduce lower back stress.
- Cushioned seat with vertical adjustment.
- Comes with Blue tooth connectivity, Speakers & Mobile phone holder.
- Maximum User Weight : 160 kgs.
- LXWXH : 135X58X144 CM.



# KH3020

## COMMERCIAL UPRIGHT BIKE



### SPECIFICATIONS

#### DRIVE

- Two stage drive with poly V-belt.
- Resistance System : Self powered hybrid brake.
- Resistance Level : 20 Levels.

#### MONITOR

- 7 window dot matrix LED display.
- Display readouts : Time, Distance, RPM, Speed, Level, Calories, Pulse and Watts .
- Various motivating programs for different workout requirements .

#### SPECIAL FEATURES

- Various seat height level adjustments.
- Accessory tray with cup holder.
- Adjustable pedal straps.
- Aluminum upright beam.
- Hidden 3 piece cranks inside crank cover for safety.
- Transport wheels.
- Adjustable floor levelers.
- Built-in receiver.
- Maximum User Weight : 180 kgs.
- LXWXH : 109X60X149 CM.



# U900

## COMMERCIAL UPRIGHT BIKE



### SPECIFICATIONS

- 5 window LED display with dot matrix showing time, speed, distance, calories, pace, heart rate etc.
- Offers various motivating programs for different workout requirements.
- Ergonomic multi grip handles with heart rate & resistance control keys.
- Weighted pedals provide gentle movement to reduce lower back stress.
- Power: Self Generator.
- Cushioned seat with vertical adjustment.
- Low maintenance and space-saving design.
- Resistance level : 32
- Large sized cup holder.
- Maximum user weight: 160 kg.
- LXWXH : 135X58X144 CM.



# U5555

## COMMERCIAL UPRIGHT BIKE

### SPECIFICATIONS

- 6 window LED display with dot matrix showing time, speed, distance, calories, pace, heart rate etc.
- Offers various motivating programs for different workout requirements.
- Ergonomic multi grip handles with heart rate & resistance control keys.
- Weighted pedals provide gentle movement to reduce lower back stress.
- Power: Self Generator.
- Low maintenance and space-saving design.
- Resistance level : 20
- 8 kg flywheel weight
- With USB charger.
- Large sized, twin cup holder with a built in tray to hold your ipad, mobile phone or magazine
- Maximum user weight: 180 kg.
- LXWXH : 105X73X149 CM.



# KH618

## COMMERCIAL UPRIGHT BIKE

### SPECIFICATIONS

#### Drive

- One stage drive with poly V-belt
- Resistance System : Self powered generator brake.
- Resistance Level : 32 Levels

#### Monitor

- LED (red light)
- Display readouts : speed, time, distance, calorie, heart rate, level, wat.
- 20 programs : 1 manual , 11 presetting, 4 HRC , 3 fittest, 1 wat.

#### Special Features

- Various seat height levels easily adjustable by knob ball
- Ergonomic stationary handle bars
- Handheld pulse sensor
- Adjustable pedal straps
- 3 piece cranks
- Transport wheels
- Built-in speakers & Bluetooth Music
- With IP support bracket
- Adjustable floor levelers
- Maximum User Weight: 180 kgs



# KH840

## COMMERCIAL UPRIGHT BIKE

### SPECIFICATIONS

- Control System: PMS intelligent electric resistance
- Heart Rate: hand-held heart rate
- Screen Display: 5-window high-brightness white light LED display
- Sports Program: built-in program 30P mode, HRC mode x 3 & WATT mode
- Resistance adjustment: 32 levels
- With 4 way seat adjustment
- Flywheel weight: 9KG two-way magnetic control wheel
- Transmission method: belt
- Motion trajectory: fixed elliptical motion trajectory
- With USB charging function, Bluetooth music input function.
- Maximum User Weight : 150kgs
- LxWxH : 115x65x152 cms



# KH565

## COMMERCIAL UPRIGHT BIKE

### SPECIFICATIONS

#### Drive

- Two stage drive with poly V-belt.
- Resistance System : Self powered
- Resistance Level : 16.

#### Monitor

- 7 window dot matrix LED display
- Display readouts : Time, Distance, Speed, Level, Calories, Pulse and Watts
- Various motivating programs for different workout requirements

#### Special Features

- The easy-to-operate seat for up and down position
- Walk-through design to get on / off easily
- Accessory tray with cup holder
- Adjustable resistance levels
- Aluminum upright beam
- Hidden 3 piece cranks inside crank cover for safety
- Transport wheels
- With easy moving wheels
- Built-in receiver
- Maximum User Weight: 150 kgs
- LxWxH : 111x56x148 cms



# AB1000

## COMMERCIAL AIR BIKE

The resistance is delivered by fan, which is driven by power and speed pedal along with two handles that move back and forth. Users are able to determine intensity level and resistance.



26 ABS blades molded into one piece which makes it more stable and quiet than traditional steel blades in using condition.



Consider electroplated steel gets rust easily, the seat support and pedals of AIR BIKE are made of aluminum alloy, which is less prone to corrosion, helping to provide long service life.

Compared to ordinary, AIR BIKE with its chain always sways and bumps and needs scheduled maintenance. AIR BIKE's V-Belt drive provides smooth and consistent ride without extra maintenance or high cost.

Maximum User Weight	150kg	Programs	3 target programs (Time, Distance, Calories), 3 Heart Rate Programs (65%, 75%, 85%), 4 Interval Programs (3 time interval and 1 distance interval )
Resistance	Air Resistance	Heart Rate Monitor	Telemetry (Compatible with Polar heart rate belt H9 or H10 which can be bought separately)
Drive Model	Belt Drive	Cup Holder	Yes
Pedals & handle bars	Synchronized Motion	Fan Size	26 inches
Pedals	Double Faced Aluminum Alloy	Fan Blades	26 ABS Curved blades
Footholds	Aluminum	Product Dimension	130 × 71 × 134 CM
Crank	Oversize		
Console Display	5" LCD Screen		
Console Readouts	Time, Speed/Average Speed, Calories/Average Calories, Distance, RPM/Average RPM, Watt/Average Watt		



This Bike enables users to do upper body training, lower body training and total body training. It helps to improve your body coordination and meets training demands of various people.

## AB700

### COMMERCIAL AIR BIKE

#### SPECIFICATIONS

- Belt transmission system with fan flywheel.
- Various motivating programs for different workout requirements.
- 3 pcs Crank system.
- Comes with horizontal and vertical saddle post adjustment.
- Transport wheels + Aluminum pedals.
- Big LCD screen with backlit.
- Quick buttons for interval program.
- Maximum user weight: 160 kg.
- LXWXH : 129x59x122 cms



## AB400

### COMMERCIAL AIR BIKE

#### SPECIFICATIONS

- System : Fan drive
- 1 manual + 12 built-in programs
- Built-in wireless receiver
- Transport wheels + Aluminium pedals
- Big LCD screen with backlit
- Quick buttons for interval program
- Maximum user weight: 150 kg.
- LXWXH : 129x59x122 cms



## KH160

### COMMERCIAL GROUP BIKE

- SPECIFICATIONS**
- Frame made from durable flat oval tube 50x120 mm
  - Belt transmission system with 20 kg rear flywheel
  - Magnetic resistance system with adjustment lever
  - Dip moulded PVC rust proof handle bar
  - Aluminium alloy seat post with 4 way adjustment
  - Maximum user weight: 160 kg.
  - LXWXH : 166X70X144 CM.



## KH159

### COMMERCIAL GROUP BIKE

- SPECIFICATIONS**
- Computer show SCAN, TIME, DISTANCE, CALORIES, SPEED, RPM. with Bluetooth including Kinomap & Zwift Wi Fi RJ 45.
  - Frame made from durable fat oval tube 50x100 mm.
  - Belt transmission system with 20 kg flywheel.
  - Friction resistance system.
  - Dip moulded PVC rust proof handle bar.
  - Aluminum alloy seat post with 4 way adjustment.
  - With commercial use crank and pedals.
  - Maximum user weight: 150 kg.
  - LXWXH : 133 x 53 x 125 cm.



## KH158

### COMMERCIAL GROUP BIKE

#### SPECIFICATIONS

- Comes with large computer display.
- Ultra sturdy structure with heavy duty 3 pcs crank.
- Fully adjustable GEL seat with sweat proof finish.
- 4 way adjustable handle bar.
- Belt transmission system with 20 kg flywheel.
- Side break system.
- SPD racing pedals.
- Transport wheels for easy movement.
- Maximum user weight: 160 kg.
- LXWXH : 119X53X105 CM.



## KH156

### COMMERCIAL GROUP BIKE

#### SPECIFICATIONS

- Comes with large computer display
- Adjustable resistance
- Racing handle bar
- With 20kgs flywheel
- 3 piece aluminum crank with SPD pedals
- Computer functions : time, speed, distance, calories & pulse
- Maximum User Weight : 150 Kgs
- LXWXH : 124X51X120 cm



## KH154

### COMMERCIAL GROUP BIKE

#### SPECIFICATIONS

- Comes with large computer display.
- Ultra sturdy structure.
- Fully adjustable GEL seat with sweat proof finish.
- 4 way adjustable handle bar.
- Belt transmission system with 20 kg flywheel.
- Side break system.
- SPD racing pedals.
- Transport wheels for easy movement.
- Maximum user weight: 150 kg.
- LXWXH : 119X53X105 CM.



## KH153

### COMMERCIAL GROUP BIKE

#### SPECIFICATIONS

- Adjustable resistance.
- Dipping handle bar.
- With 20kgs flywheel.
- With adjustable seat.
- Computer functions : time, speed, distance, calories & pulse.
- Maximum User Weight 140 Kgs.
- LXWXH : 115X50X123 CM.



## KH142

### COMMERCIAL GROUP BIKE

#### SPECIFICATIONS

- Ultra sturdy with heavy duty crank.
- Fully adjustable Gel seat with sweat proof finish.
- With 18 kg flywheel.
- Adjustable handle bar with up & down position.
- High quality ribbed belt with tension wheel driving system.
- Press type braking system.
- Rust proof aluminum seat and handle tube.
- Maximum user weight : 150 kg.
- LXWXH : 107X58X112 CM.



# AR1000

## COMMERCIAL AIR ROWER



Drive Model	Chain
Maximum User Weight	150kg
Resistance Design	Air Resistance
Console Display	5" LCD display with 8 readout windows
Console Readouts	Time, Stroke Rate, Pace, Distance, Watts, Calories, Heart Rate, Level
Programs	Multiple
HR Monitor	Telemetry (Compatible with Polar heart rate belt H9 or H10 which can be bought separately)
Product Dimension	224 × 36 × 106 CM

# AR800

## COMMERCIAL AIR ROWER



### SPECIFICATIONS

- Unique fan plus magnetic wheel system.
- Durable chain drive with 1-way bearing.
- Air+magnetic dual resistance.
- Aluminum rowing rail with stainless top surface.
- Dual adjustable console.
- Comfortable & smooth rowing seat.
- Ultra adjustable pedal.
- Max. User weight: 160 kgs.
- Lxwxh : 224x35x150 cm.

## AR600

### COMMERCIAL AIR ROWER



#### SPECIFICATIONS

- Unique fan plus magnetic wheel system.
- Durable chain drive with 1-way bearing.
- Air+magnetic dual resistance.
- Aluminum rowing rail with stainless top surface.
- Dual adjustable console.
- KINOMAP compatible through bluetooth.
- Comfortable & smooth rowing seat.
- Ultra adjustable pedal.
- Max. User weight: 160 kgs.
- LXWXH : 224x35x150 cm.

## AR500

### COMMERCIAL AIR ROWER

#### SPECIFICATIONS

- Solid steel frame that folds up for easy storage.
- Air generated 10 levels resistance.
- High strength steel chain rowing strap for a smooth and quiet pull.
- Back-lit bright LCD monitor that displays all workout data.
- Compatible with FITLOG, KINOMAP and ZWIFT.
- High quality contoured seat.
- Adjustable footrest with numbered setting
- Max. user weight: 160 Kgs.
- LXWXH : 241X62X111 CM.



# SR1000

## COMMERCIAL SKI / AIR ROWER

Maximum User Weight	150kg
Drive Model	Belt
Handlebar Design	Rowing Bar & Skiing Bar
Flywheel Weight	4.1 kg
Special Features	Provided Rowing & Skiing Training
Resistance Design	MARS (Magnetic & Air Resistance System)
Resistance Power	300W
Resistance Levels	20
Console Display	5" LCD display with 8 readout windows
Console Readouts	Time, Stroke Rate, Pace, Distance, Watts, Calories, Heart Rate, Level
Programs	5 (Time/Distance/Calorie Target, Interval Time/Distance)
HR Monitor	Telemetry (Compatible with Polar heart rate belt H9 or H10 which can be bought separately)
Product Dimension	Horizontal Form: 262 x 88 x 106 CM Vertical Form: 136 x 88 x 214 CM
Seat Height	513mm/ 20.2"
Monorail	1663mm/ 65.5" (Aluminum)

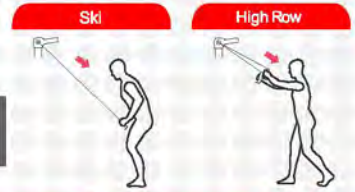

The transport wheels make it easy to place to a workout space.



MARS (Magnetic & Air Resistance System) allows users to control their exertion and resistance at all times. The MARS system comes with 20 settings so you can change the resistance to suit your performance.



Adjustable angles of console provides users with the best viewing experience



High intensity cords achieve the maximum strength test up to 1,000,000 times ensuring the high quality of product.



Ergonomic seat enables users to train comfortably. Light-weight aluminum and stainless steel made siderail allows users to train intensively and provide a low maintenance.



Adjustable pedals and ergonomic handle bars accommodate different user's need. The sturdy legs provide users a comfortable and stable movement.



The SKI&ROW can be used in standing form, which provides upper body training and core training. Optional foot straps help users to train lower body and complete the workout shown below:



## SKI600

### SKI MACHINE

#### SPECIFICATIONS

- Durable and ergonomic construction.
- Can be either mounted on a wall or with specially designed anti-skid floor stand.
- Air generated 10 levels resistance.
- High strength light weight drive cord with strapless handles for secure grip.
- Back-lit bright LCD monitor that displays all workout data.
- KINOMAP compatible through bluetooth.
- Max. user weight: 160 Kgs.
- LXWXH : 128X62X216 CM.



## SKI 500

### SKI MACHINE

#### SPECIFICATIONS

- Durable and ergonomic construction.
- Can be either mounted on a wall or with specially designed anti-skid floor stand.
- Air generated 10 levels resistance.
- High strength light weight drive cord with strapless handles for secure grip.
- Back-lit bright LCD monitor that displays all workout data.
- Compatible with FITLOG, KINOMAP and ZWIFT.
- Max. user weight: 160 Kgs.
- LXWXH : 128X62X216 CM.



# INFINITY TRAINER

## SPECIFICATIONS

- Unique machine with variety of exercises possible.
- Heavy duty stainless steel base.
- Dimensions : 220x135x162 cms
- Weight : 160 kgs



# TYRE FLIP 180

## SPECIFICATIONS

- Starting resistance of 100 lbs.
- Plate loaded ability up to 40 additional pounds.
- 4 sounds reducing bumpers .
- 2 battle rope anchor points.
- 4 floor levelers.
- 8 floor mounting points.
- Weight of the tyre : 49 kgs.
- Weight of the machine : 145 kgs.
- LXWXH : 164X124X60 CM.



# KH5050

## STEPMILL



### SPECIFICATIONS

- Magnetic EMS system.
- Console : 6 window LED dot-matrix display.
- Speed & Start / Stop button on handle bar.
- Data readout : Speed level, calories, time, distance, steps etc.
- Program : P1-36 + FAT + User / Countdown / Manual - Floor mode & Cool down.
- 3 - Emergency stop switch including infrared sensor.
- Step size : 21" wide step, 11" deep & 8" height
- Comes with wireless charger.
- With water bottle holder.
- Max user weight : 180 kgs.
- LXWXH : 167X87X131 CM.

# KH4040

## STEPMILL



### SPECIFICATIONS

- Magnetic EMS system.
- Console : LED dot-matrix display.
- Speed & Start / Stop button on handle bar.
- Data readout : Speed level, calories, time, distance, steps etc.
- Program : Various motivating programs for different workout requirements.
- With water bottle holder.
- Max user weight : 160 kgs.
- LXWXH : 145X82X208 CM.

# KH3030

## STEPMILL



Big comfortable paddles

### SPECIFICATIONS

- Magnetic EMS system.
- Console : LED dot-matrix display
- Data readout : Speed level, calories, time, distance, steps etc.
- Program : Various motivating programs for different workout requirements.
- With water bottle holder.
- Max user weight : 150 kgs.
- LXWXH : 145X82X208 CM.

# GYM FAN

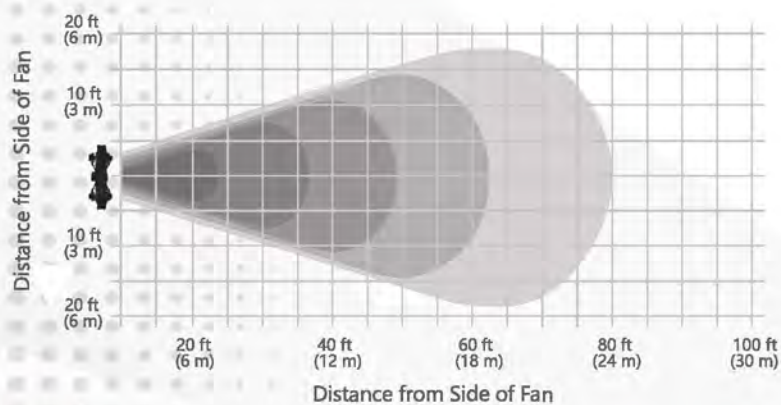

## PRODUCT HIGHLIGHTS

- 1 Stepless Speed Adjustment**
- 2 Highly Mobile with four wheel movement and foot locks**
- 3 Durable Frame Structure**

## PRODUCT SPECIFICATIONS

**Dimension :** 2140\*690\*2030mm  
**Power :** 1.1kw  
**Controller :** Variable speed control  
**Weight :** 150kg  
**Airflow :** 24 meters length

A highly muscular Black male bodybuilder is shown in a gym, performing a lat pulldown exercise. He has a very large, thick braid that runs down the center of his chest and abdomen. He is wearing black briefs and is pulling down on a metal handle attached to a cable. His muscles are extremely defined and glistening. In the background, there are gym machines and a sign that says "ARMS".

**VIVA<sup>®</sup>**  
**FITNESS**

**# PushYourself**

# SIGNATURE SERIES UNIQUE FEATURES

Integrated weight stack tower that offers both safety environmental protection

304 stainless steel rotating shaft which is strong, durable and beautiful

PU moulded foam cushions - Environmentally friendly, comfortable and durable

High quality  $\phi$  4.8mm cable - smooth operation, high strength and long life

Select pin is made of 6063 aluminum for smooth, durable and noiseless movement. Surface oxidation red treatment

Stainless steel adjusting plate



## PC2101

### MULTI PRESS

- LXWXH : 198X135X166 CM.
- Weight stack : 150 LBS.

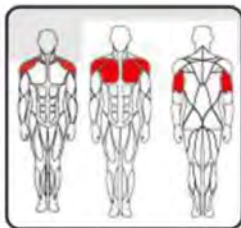

## PC2102

### LAT PULL / SEATED ROW

- LXWXH : 188X121X225 CM.
- Weight stack : 190 LBS.

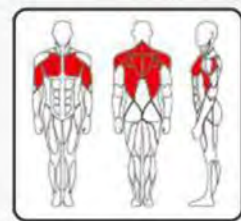

## PC2103

### PEC FLY / REAR DELT

- LXWXH : 137X150X195 CM.
- Weight stack : 220 LBS.

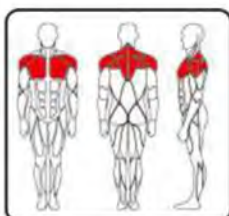

## PC2104

### DIP / CHIN ASSIST

- LXWXH : 116X154X220 CM.
- Weight stack : 170 LBS.

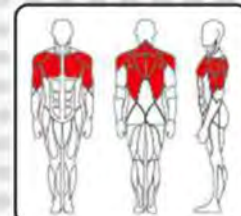

## PC2105

### LEG EXTENSION / LEG CURL

- LXWXH : 161X133X158 CM.
- Weight stack : 220 LBS.

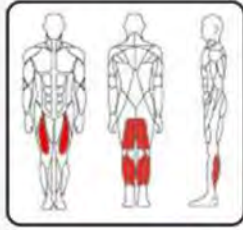

## PC2106

### HIP ABDUCTOR / ADDUCTOR

- LXWXH : 167X73X158 CM.
- Weight stack : 150 LBS.

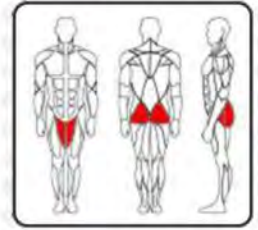

## PC2107

### BICEP CURL / TRICEPS EXTENSION

- LXWXH : 124X131X158 CM.
- Weight stack : 220 LBS.



## PC2108

### LEG PRESS / CALF EXTENSION

- LXWXH : 194X114X158 CM.
- Weight stack : 290 LBS.

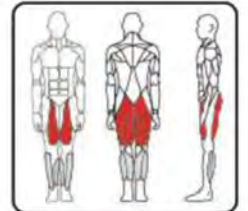

## PC2109

ABDOMINAL / BACK EXTENSION

- LXWXH : 131X121X158 CM.
- Weight stack : 200 LBS.

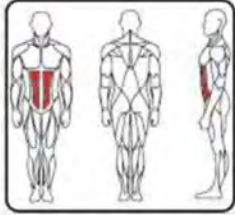

## PC2110

DEEP SQUAT / STANDING CALF EXTENSION

- LXWXH : 130X115X158 CM.
- Weight stack : 220 LBS.

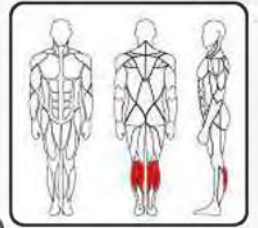

## PC2111

ROTARY HIP

- LXWXH : 148X93X158 CM.
- Weight stack : 150 LBS.

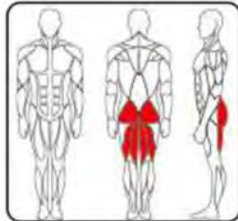

## PC2122

LAT PULLDOWN

- LXWXH : 167X143X202 CM.
- Weight stack : 300 LBS.

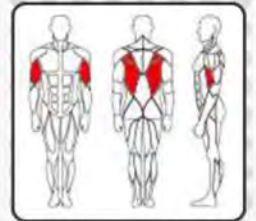

## PC2201

### CHEST PRESS

- LXWXH : 97X152X182 CM.
- Weight stack : 240 LBS.



## PC2202

### SEATED ROW

- LXWXH : 159X108X150 CM.
- Weight stack : 230 LBS.

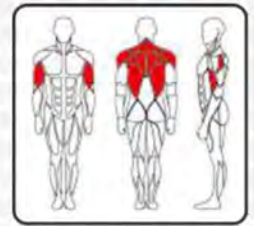

## PC2203

### SHOULDER PRESS

- LXWXH : 171X146X150 CM.
- Weight stack : 240 LBS.



## PC2204

### TORSO ROTATION

- LXWXH : 86X126X150CM.
- Weight stack : 120 LBS.

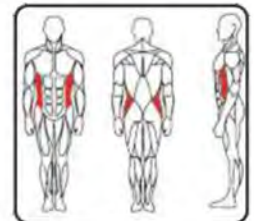

## PC2205

### LEG EXTENSION

- LXWXH : 127X121X150 CM.
- Weight stack : 230 LBS.

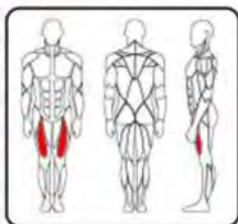

## PC2206

### SEATED LEG CURL

- LXWXH : 143X121X150 CM.
- Weight stack : 230 LBS.

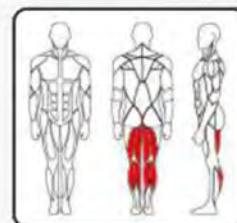

## PC2211

### SEATED LEG PRESS

- LXWXH : 186X114X150 CM.
- Weight stack : 330 LBS.

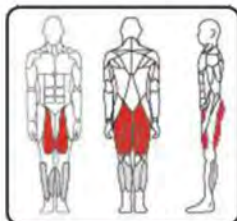

## PC2212

### DELTOID TRAINER

- LXWXH : 150X88X157 CM.
- Weight stack : 120 LBS.

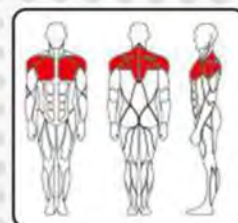

## PC2215

### HIP TRAINER

- LXWXH : 163X113X150 CM.
- Weight stack : 150 LBS.

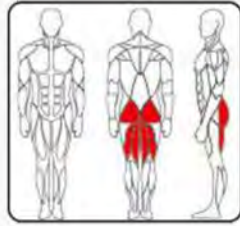

## PC2218

### PRONE LEG CURL

- LXWXH : 173X124X150 CM.
- Weight stack : 230 LBS.

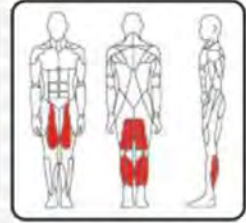

## PC2222

### LATERAL RAISE

- LXWXH : 94X119X150 CM.
- Weight stack : 150 LBS.

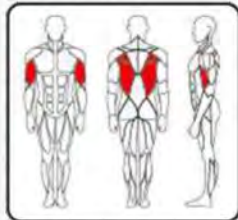

## PC2223

### NECK BENDING MACHINE

- LXWXH : 168X88X158 CM.
- Weight stack : 200 LBS.

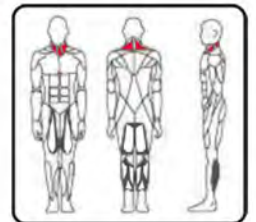

## PC2230

### CABLE CROSSOVER

- LXWXH : 414X76X236 CM.
- Weight stack : 220 LBS X 2.



## PC2235

### FUNCTIONAL TRAINER

- LXWXH : 166X123X242 CM.
- Weight stack : 220 LBS X 2.

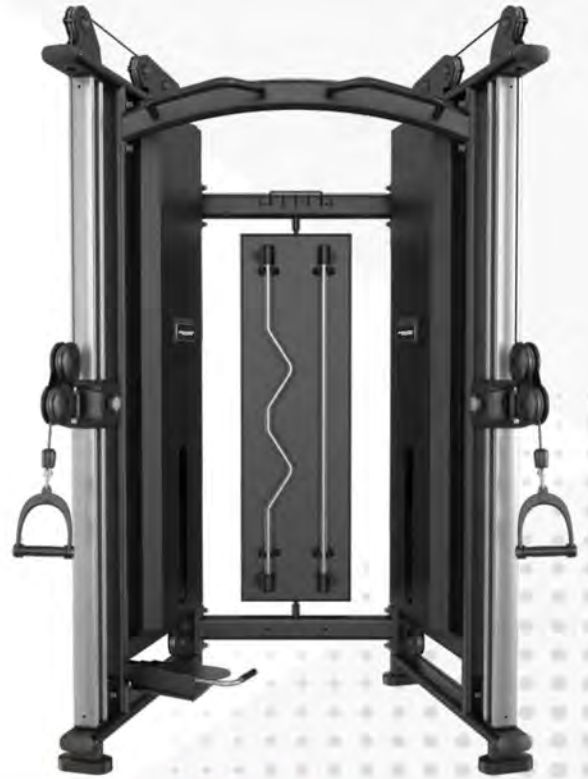

## PC2240

### SMITH MACHINE

- Counter Balanced.
- Comes with Aluminum pulley.
- LXWXH : 140X209X250 CM.



## PC2245

### DUAL ARM FUNCTIONAL TRAINER

- Counter Balanced.
- Weight stack : 220 LBS X 2.
- WIDTH : 89 CM & HEIGHT 200 CM



## PC1013

### BICEP CURL

- LXWXH : 148X108X119 CM.
- MAX WEIGHT CAPACITY : 150KG / 330 LBS.

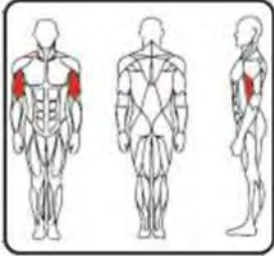

## PC1015

### HIP THRUST

- LXWXH : 162X124X81 CM.
- MAX WEIGHT CAPACITY : 200KG / 440 LBS.

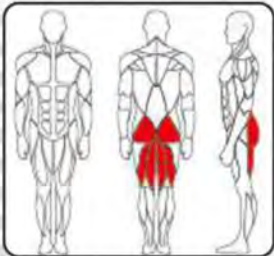

## PC1018

### POWER SQUAT

- LXWXH : 199X129X140 CM.
- MAX WEIGHT CAPACITY : 400KG / 880 LBS

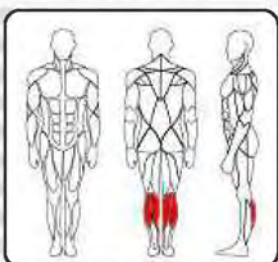

## PC1021

### PENDULUM SQUAT

- LXWXH : 213X162X96 CM.
- MAX WEIGHT CAPACITY : 200KG / 440 LBS

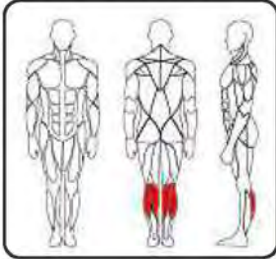

## PC1022

### DEEP BELT SQUAT

- LXWXH : 172X175X143 CM.
- MAX WEIGHT CAPACITY : 350KG / 770 LBS.
- COMES WITH BELT ATTACHMENT.

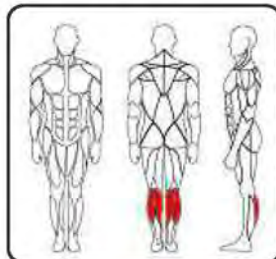

## PC3013

### LEG EXTENSION / PRONE LEG CURL

- UNIQUE LOAD DROP MECHANISM, ALLOWS FOR UP TO 30% WEIGHT REDUCTION.
- LXWXH : 141X134X103 CM.
- MAX WEIGHT CAPACITY : 150KG / 330 LBS



## PC3008

### ISO LATERAL LEG PRESS

- UNIQUE LOAD DROP MECHANISM, ALLOWS FOR UP TO 30% WEIGHT REDUCTION
- LXWXH : 217X186X154 CM.
- MAX WEIGHT CAPACITY : 500KG / 1100 LBS

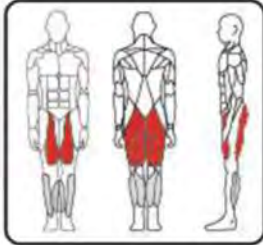

## PC3016

### HIP ABDUCTOR

- LXWXH : 152X93X145 CM.
- MAX WEIGHT CAPACITY : 150KG / 330 LBS

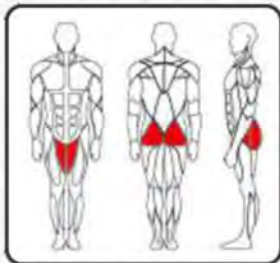

## PC1116

### 45 DEGREE LEG PRESS

- LXWXH : 214X161X140 CM.
- MAX WEIGHT CAPACITY : 600KG / 1300 LBS

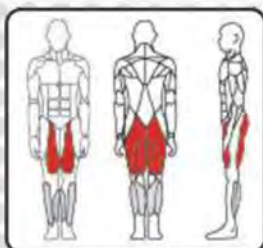

**VIVA**<sup>®</sup>  
**FITNESS**

**# PushYourself**



# LEGACY SERIES UNIQUE FEATURES

✦ Long lasting upholstery - 15mm thick plywood backing followed by 45mm thick foam core covered by industrial vinyl

✦ Aircraft spec 5mm American LOOS cable with 4,200 lb breaking strength. All fittings tested for 250,000 cycles using full weight stack.

✦ 3mm thick, 65mm by 114mm racetrack tubing, electro-welded for maximum strength.  
✦ Electrostatic powder coated and heat cured paint finish for maximum durability.



✦ Easy-to-use seat with minimal adjustments and pre-stretched features optimal exercise positions.

✦ Compact - space efficient design requires minimal floor space.  
✦ Rubber grip prevent from being slipped.

## IP1001

### CHEST PRESS

- LXWXH : 142X107X149 CM.
- Weight stack : 175 LBS.



## IP1003

### ARM CURL

- LXWXH : 130X119X149 CM.
- Weight stack : 175 LBS.



## IP1005

### LEG EXTENSION

- LXWXH : 147X112X148 CM.
- Weight stack : 220 LBS.



## IP1006

### LEG CURL

- LXWXH : 149X112X148 CM.
- Weight stack : 175 LBS.



## IP1008

### ABDUCTOR / ADDUCTOR

- LXWXH : 166X78X149 CM.
- Weight stack : 275 LBS.



## IP1010

### LEG PRESS

- LXWXH : 210X108X149 CM.
- Weight stack : 220 LBS.



## IP1012

### SHOULDER PRESS

- LXWXH : 170X147X149 CM.
- Weight stack : 175 LBS.



## IP1014

### ABDOMINAL

- LXWXH : 142X107X149 CM.
- Weight stack : 175 LBS.



## IP1015

### PEC FLY / REAR DELT

- LXWXH : 190X132X203 CM.
- Weight stack : 220 LBS.



## IP1017

### TRICEP PRESS

- LXWXH : 130X115X149 CM.
- Weight stack : 180 LBS.



## IP1019

### SEATED ROW

- LXWXH : 133X112X149 CM.
- Weight stack : 220 LBS.



## IP1020

### DIP CHIN / ASSIST

- LXWXH : 164X148X223 CM.
- Weight stack : 220 LBS.



## IP1021

### PRONE LEG CURL

- LXWXH : 165X104X148 CM
- Weight stack : 220 LBS.



## IP1022

### LAT PULL / SEATED ROW

- LXWXH : 170X130X160 CM.
- Weight stack : 220 LBS.



## IP1024

### LATERAL RAISE

- LXWXH : 125X120X149 CM.
- Weight stack : 175 LBS.



## IP1025

### CABLE CROSS OVER

- LXWXH : 435X80X221 CM.
- Weight stack : 175 LBS X 2.

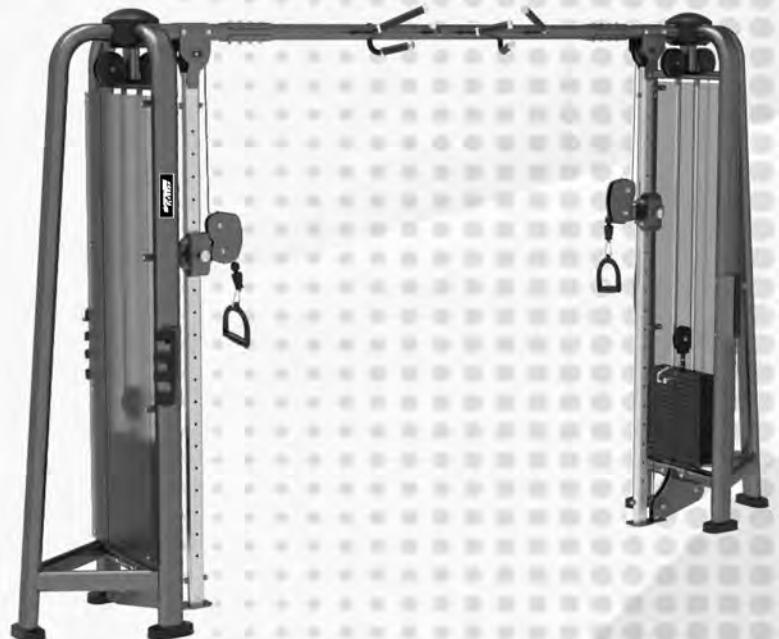

## IP1027

### 5 STATION JUNGLE GYM

- LXWXH : 566X376X242 CM.
- Weight stack : 175 LBS X 5.

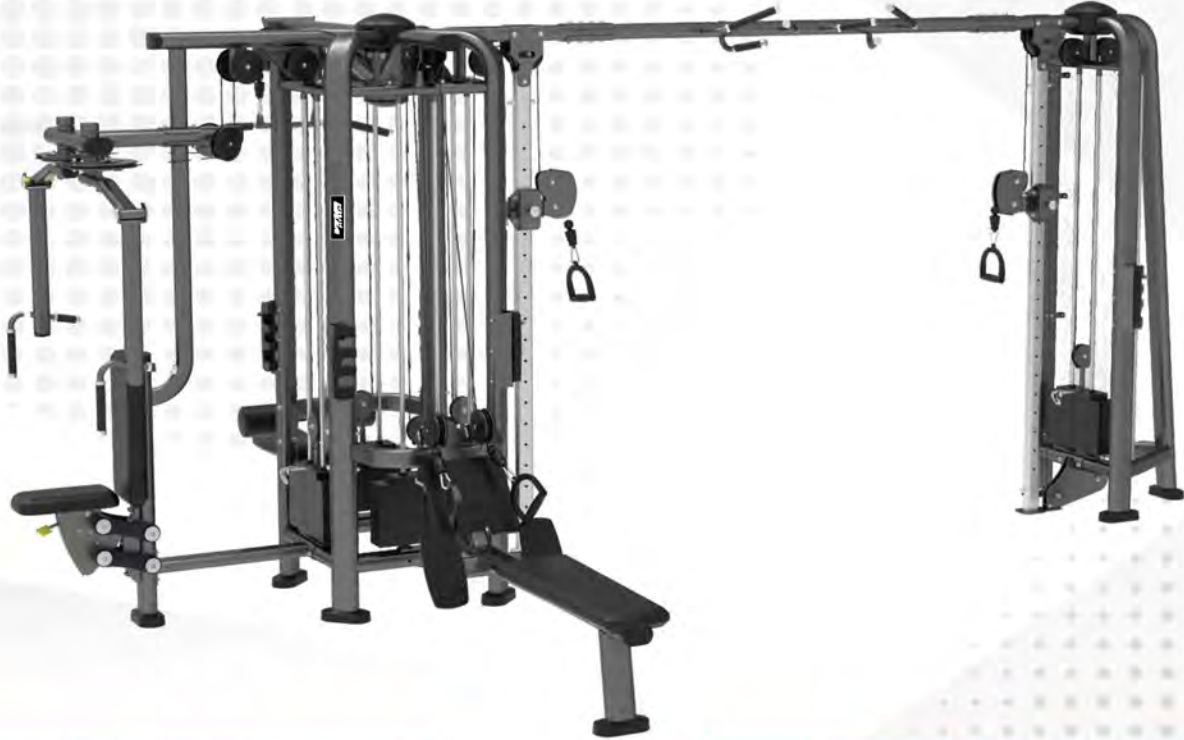

## IP1028

### LEG CURL/ EXTENSION

- LXWXH : 149X112X148 CM.
- Weight stack : 220 LBS.



## IP1029

### MULTI PRESS

- LXWXH : 170X126X130 CM.
- Weight stack : 220 LBS.



## IP1030

### DUAL ADJUSTABLE PULLEY

- LXWXH : 158X120X244 CM.
- Weight stack : 175 LBS X 2.



## IP1033

### BICEP / TRICEP

- LXWXH : 130X119X149
- Weight stack : 175 LBS.



## IP1034

### BACK EXTENSION / ABDOMINAL

- LXWXH : 140X112X149
- Weight stack : 175 LBS.



## IP1501

### COUNTER BALANCED SMITH MACHINE

- LXWXH : 125X221X237 CM.



## IP1502

### STANDING ARM CURL

- LXWXH : 84X120X117 CM.



## IP1503

### ABDOMINAL CRUNCH BENCH

- LXWXH : 169X89X98 CM.



## IP1507

### HYPER EXTENSION BENCH

- LXWXH : 127X68X97 CM.



## IP1509

### FLAT BENCH

- LXWXH : 126X168X42 CM.



## IP1510

### CHIN DIP / LEG RAISE

- LXWXH : 130X173X240 CM.



## IP1511

### MULTI ADJUSTABLE BENCH

- LXWXH : 135X82X45 CM.



## IP1513

### ADJUSTABLE AB BENCH

- LXWXH : 168X68X82 CM.



## IP1514

### OLYMPIC FLAT BENCH

- LXWXH : 183X168X125 CM.



## IP1515

### OLYMPIC INCLINE BENCH

- LXWXH : 209X200X144 CM.



## IP1516

### OLYMPIC DECLINE BENCH

- LXWXH : 217X170X143 CM.



## IP1522

### UTILITY BENCH

- LXWXH : 91X68X110 CM.



# IT SERIES UNIQUE FEATURES

✦ Long lasting upholstery - 20mm thick plywood backing followed by 40mm thick foam core covered by industrial vinyl



✦ Aircraft spec 5mm American LOOS cable with 4,200 lb breaking strength. All fittings tested for 250,000 cycles using full weight stack.

✦ Easy-to-use seat with minimal adjustments and pre-stretched features optimal exercise positions.

✦ 3mm thick, 50mm by 100 mm racetrack tubing, electro-welded for maximum strength.  
✦ Electrostatic powder coated and heat cured paint finish for maximum durability.

✦ Compact - space efficient design requires minimal floor space.  
✦ Rubber grip prevent from being slipped.

## IT9501

### CHEST PRESS

- LXWXH : 148X120X150 CM
- Weight Stack : 200 lbs



## IT9502

### LAT PULLDOWN

- LXWXH : 143X138X188 CM
- Weight Stack : 295 lbs



## IT9503

### ARM CURL

- LXWXH : 130X121X150 CM
- Weight Stack : 160 lbs



## IT9504

### PECTORAL

- LXWXH : 150X146X150 CM
- Weight Stack : 200 lbs



## IT9505

### LEG EXTENSION

- LXWXH : 154X119X150 CM
- Weight Stack : 200 lbs



## IT9506

### SEATED LEG CURL

- LXWXH : 147X120X150 CM
- Weight Stack : 200 lbs



## IT9508

### ABDUCTOR / ADDUCTOR

- LXWXH : 155X90X150 CM
- Weight Stack : 160 lbs



## IT9509

### TOTAL HIP

- LXWXH : 130X98X150 CM
- Weight Stack : 200 lbs



## IT9510

### LEG PRESS

- LXWXH : 180X120X150 CM
- Weight Stack : 295 lbs



## IT9512

### SHOULDER PRESS

- LXWXH : 156X144X151 CM
- Weight Stack : 200 lbs



## IT9514

### ABDOMINAL

- LXWXH : 135X115X158 CM
- Weight Stack : 200 lbs



## IT9515

### PEC FLY / REAR DELT

- LXWXH : 166X129X200 CM
- Weight Stack : 200 lbs



## IT9516

### STANDING CALF

- LXWXH : 135X115X158 CM
- Weight Stack : 235 lbs



## IT9517

### TRICEP PRESS

- LXWXH : 179.4X126X150 CM
- Weight Stack : 200 lbs



## IT9518

### ROTARY TORSO

- LXWXH : 122X120X150 CM
- Weight Stack : 160 lbs



## IT9519

### VERTICAL ROW

- LXWXH : 144X114X150 CM
- Weight Stack : 200 lbs



## IT9520

### DIP / CHIN ASSIST

- LXWXH : 122X136X220 CM
- Weight Stack : 200 lbs



## IT9521

### PRONE LEG CURL

- LXWXH : 147X120X150 CM
- Weight Stack : 200 lbs



## IT9522

### LAT PULL / SEATED ROW

- LXWXH : 135X115X158 CM
- Weight Stack : 295 lbs



## IT9524

### LATERAL RAISE

- LXWXH : 122X121X150 CM
- Weight Stack : 200 lbs



## IT9526

### GLUTE

- LXWXH : 150X124X150 CM
- Weight Stack : 200 lbs



## IT9528

### LEG EXTENSION / LEG CURL

- LXWXH : 135X122X150 CM
- Weight Stack : 235 lbs



## IT9529

### MULTI PRESS

- LXWXH : 182X143X166 CM
- Weight Stack : 235 lbs



## IT9533

### BICEP CURL / TRICEP EXTENSION

- LXWXH : 130X124X150 CM
- Weight Stack : 200 lbs



## IT9534

BACK EXTENSION /  
ABDOMINAL

- LXWXH : 119X118X150 CM
- Weight Stack : 200 lbs



## IT9537

STANDING MULTI FLIGHT MACHINE

- LXWXH : 145X90X186 CM
- Weight Stack : 200 lbs



## IT7001

COUNTER BALANCED  
SMITH MACHINE

- LXWXH : 138X225X229 CM.



## IT7002

### SEATED PREACHER CURL

- LXWXH : 101X81X88 CM.



## IT7003

### AB BENCH

- LXWXH : 175X94X100 CM.



## IT7005

### SEATED CALF RAISE

- LXWXH : 135X75X83 CM.



## IT7006

45° LEG PRESS / HACK SQUAT

- LXWXH : 225X98X146 CM.



## IT7007

MULTI  
HYPER EXTENSION

- LXWXH : 121X73X93 CM.



## IT7009

FLAT BENCH

- LXWXH : 115X90X42 CM.



## IT7010

VERTICAL KNEE RAISE / DIP STAND

- LXWXH : 112X78X155 CM.



## IT7011

MULTI ADJUSTABLE  
BENCH

- LXWXH : 121X75X46 CM.



## IT7012

12 PAIRS  
DUMBBELL RACK

- LXWXH : 159X81X98 CM.



## IT7013

MULTI AB BENCH

- LXWXH : 173X72X89 CM.



## IT7014

OLYMPIC FLAT BENCH

- LXWXH : 170X166X137 CM.



## IT7015

### OLYMPIC INCLINE BENCH

- LXWXH : 163X165X137 CM.



## IT7016

### OLYMPIC DECLINE BENCH

- LXWXH : 210X166X137 CM.



## IT7017

### OLYMPIC WEIGHT TREE

- LXWXH : 96X63X120 CM.



## IT7022

### UTILITY BENCH



# BS SERIES UNIQUE FEATURES

✦ Long lasting upholstery - 20mm thick plywood backing followed by 40mm thick foam core covered by industrial vinyl

✦ Non absorbing PVC compound retained with aluminum collars

✦ Black painted steel weight plates with self aligning low friction sleeves  
✦ Magnetic color coded pin with coiled lanyard  
✦ 5mm coated steel cable for smooth and secure performance  
✦ Glass fiber reinforced nylon pulleys with deep V-groove that provides secured cable positioning and fluid bearing rotation



✦ 60mm x 120mm Heavy guage flat oval steel tubing  
✦ Electrostatic powder coated and heat cured paint finish for maximum durability

✦ Compact - space efficient design requires minimal floor space  
✦ Rubber grip prevent from being slipped

## BS008

### LEG CURL/EXTENSION

- LXWXH : 132X138X153 CM.
- Weight stack : 220 LBS.



## BS009

### MULTI PRESS

- LXWXH : 197X153X153 CM.
- Weight stack : 220 LBS.



## BS010

### PULL DOWN/MID ROW

- LXWXH : 197X152X211 CM.
- Weight stack : 220 LBS.



## BS011

### PEC FLY/REAR DELT

- LXWXH : 179X114X202 CM.
- Weight stack : 220 LBS.



## BS012

### BICEPS CURL/TRICEPS PRESS

- LXWXH : 138X115X153 CM.
- Weight stack : 220 LBS.



## BS013

### ABDOMINAL/BACK EXTENSION

- LXWXH : 132X138X153 CM.
- Weight stack : 220 LBS.



## BS015

### LEG PRESS/CALF RAISE

- LXWXH : 187X118X153 CM.
- Weight stack : 220 LBS.



## BS016

### HIP ABDUCTION/ADDUCTION

- LXWXH : 157X94X153 CM.
- Weight stack : 220 LBS.



## BS017

### DIP / CHIN ASSIST

- LXWXH : 188X123X215 CM.
- Weight stack : 220 LBS.



## BS018

### ADJUSTABLE HI/LO PULLEY

- LXWXH : 108X101X224 CM.
- Weight stack : 220 LBS.



## BS110

### SMITH SQUAT COMBO

- LXWXH : 224X180X213 CM



## BS120

### LEG PRESS / HACK SQUAT

- LXWXH : 221X113X150 CM



## BS130

### FUNCTIONAL TRAINER

- LXWXH : 207X122X230 CM
- WEIGHT STACK : 220 LBS X 2



## BS140

### CABLE CROSSOVER

- LXWXH : 360X146X239 CM
- WEIGHT STACK : 220 LBS X 2

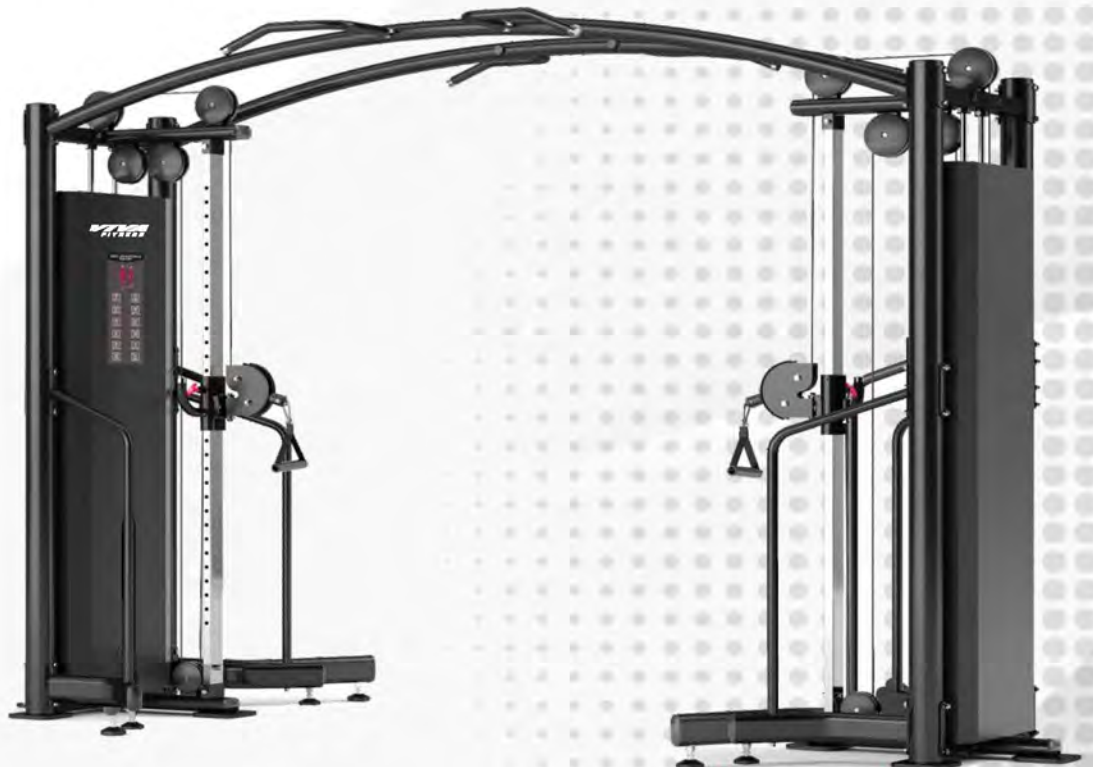

# KG BLACK SERIES UNIQUE FEATURES

- ✦ Main frame: Flat Oval tube (50\*120\*2.5T)
- ✦ Press arm: Round tube (60/50\*3.0T) Flat oval tube (40\*80\*3.0T)
- ✦ Connecting assembly: Flat oval tube (50\*120\*2.5T)

- ✦ The cushion is made of PU and it's hardness is designed according to the principles of ergonomics and controlled to be around HBS-65±5, which assures that it's suitable for almost all users.
- ✦ The upholstery leather does not peel off or fade after getting rubbed 8000 times with a 500g weight.



WITH COUNTER

- ✦ Water bottle holder

- ✦ Front shroud is made of ABS & back shroud is made of Cold rolled steel plate

- ✦ 5 level seat adjustment system

- ✦ High tempered alloy steel guide rod.
- ✦ Heavy duty steel cable with 1000 kg load capacity & tested for 100,000 rounds of endurance.
- ✦ Steel weight stacks.



## KG6501

### CHEST PRESS

- LXWXH : 145X111X168 CM
- WEIGHT STACK : 220 LBS



## KG6502

### LAT PULL DOWN

- LXWXH : 183X151X203 CM
- WEIGHT STACK : 220 LBS



## KG6503

### BICEP CURL

- LXWXH : 130X97X168 CM
- WEIGHT STACK : 155 LBS



## KG6504

### ADJUSTABLE LAT PULL DOWN

- LXWXH : 183X151X203 CM
- WEIGHT STACK : 220 LBS



## KG6505

### LEG EXTENSION

- LXWXH : 136X108X168 CM
- WEIGHT STACK : 175 LBS



## KG6508

### ABDUCTOR/ADDUCTOR

- LXWXH : 163X88X168 CM
- WEIGHT STACK : 175 LBS



## KG6510

### LEG PRESS

- LXWXH : 195X110X168 CM
- WEIGHT STACK : 265 LBS



## KG6512

### SHOULDER PRESS

- LXWXH : 164X148X168 CM
- WEIGHT STACK : 175 LBS



## KG6515

### PECFLY/REARDELT

- LXWXH : 152X112X205 CM
- WEIGHT STACK : 220 LBS



## KG6517

### TRICEP PRESS

- LXWXH : 137X99X168 CM
- WEIGHT STACK : 220 LBS



## KG6519

### SEATED ROW

- LXWXH : 144X88X168 CM
- WEIGHT STACK : 220 LBS



## KG6520

### ASSISTED CHIN/DIP

- LXWXH : 145X132X237 CM
- WEIGHT STACK : 175 LBS



## KG6521

### PRONE LEG CURL

- LXWXH : 170X103X168 CM
- WEIGHT STACK : 175 LBS



## KG6522

### LAT PULL/SEATED ROW

- LXWXH : 190X152X210 CM
- WEIGHT STACK : 220 LBS



## KG6528

### LEG EXTENSION/CURL

- LXWXH : 140X120X166 CM
- WEIGHT STACK : 220 LBS



## KG6529

### MULTI PRESS

- LXWXH : 195X146X166 CM
- WEIGHT STACK : 175 LBS



## KG6533

### BICEPS/TRICEPS

- LXWXH : 125X125X166 CM
- WEIGHT STACK : 175 LBS



## KG6535

### SEATED HORIZONTAL PULLEY

- LXWXH : 179X107X168 CM
- WEIGHT STACK : 220 LBS



## KG6536

### STANDING MULTI FLIGHT

- LXWXH : 148X80X228 CM
- WEIGHT STACK : 220 lbs



## KG6546

### FUNCTIONAL TRAINER

- LXWXH : 163X108X225 CM
- WEIGHT STACK : 220 LBS X 2



## KG6545

### CABLE CROSSOVER

- LXWXH : 370X89X225 CM
- WEIGHT STACK : 220 LBS X 2



## KG6555

### OLYMPIC FLAT BENCH

- LXWXH : 183X127X120 CM



## KG6556

### OLYMPIC DECLINE BENCH

- LXWXH : 202X127X120 CM



## KG6557

### OLYMPIC INCLINE BENCH

- LXWXH : 207X126X135 CM



## KG6558

### BACK EXTENSION BENCH

- LXWXH : 123X66X78 CM



## KG6559

### AB BENCH

- LXWXH : 185X72X110 CM



## KG6560

### T ARM MACHINE

- LXWXH : 189X85X81 CM



## KG6561

### STRETCH MACHINE

- LXWXH : 157X52X94 CM



## KG6562

### FLAT BENCH

- LXWXH : 150X73X45 CM



## KG6563

### MULTI ADJUSTABLE BENCH

- LXWXH : 136X56X107 CM



## KG6564

### UTILITY BENCH

- LXWXH : 103X52X105 CM



**KG6565**

**BARBELL RACK**

- LXWXH : 103X88X142 CM



**KG6566**

**PREACHER CURL BENCH**

- LXWXH : 97X74X97 CM



**KG6567**

**SQUAT RACK**

- LXWXH : 167X136X234 CM



**KG6568**

**VERTICAL KNEE RAISE WITH CHIN DIP**

- LXWXH : 130X119X235 CM



**KG6569**

**SEATED CALF**

- LXWXH : 138X60X94 CM





**# PushYourself**



# SELECT LINE UNIQUE FEATURES

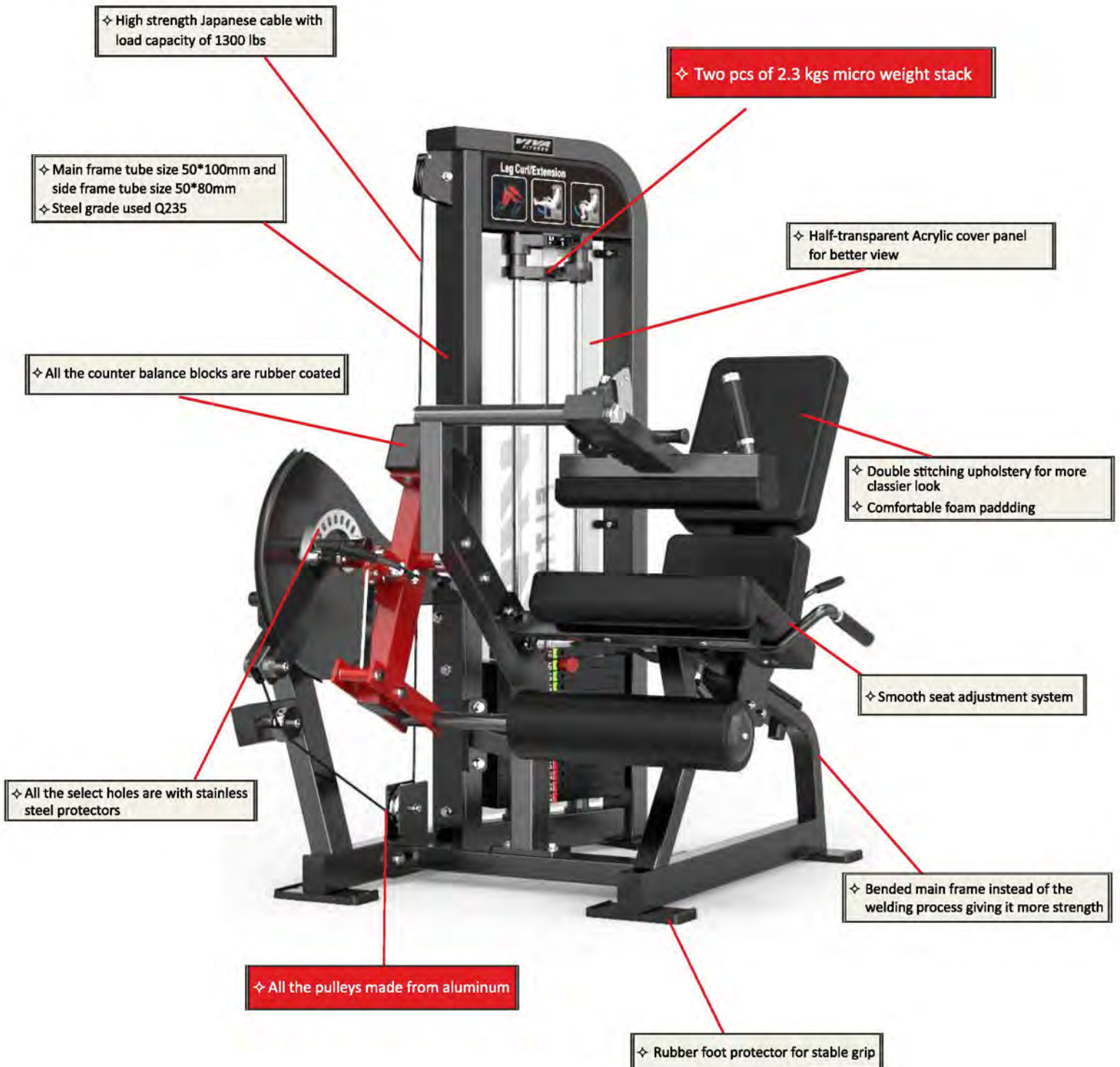

## BR01

### CHEST PRESS

- LXWXH: 150X110X163 CM
- WEIGHT STACK : 220 LBS



## BR02

### SHOULDER PRESS

- LXWXH: 136X143X163 CM
- WEIGHT STACK : 220 LBS



## BR04

### PEC FLY / REAR DELT

- LXWXH: 126X148X198 CM
- WEIGHT STACK : 220 LBS



## BR05

### BICEP CURL

- LXWXH: 114X110X140 CM
- WEIGHT STACK : 220 LBS



## BR07

### LATERAL RAISE

- LXWXH: 110X100X163 CM
- WEIGHT STACK : 190 LBS



## BR08

### LAT PULLDOWN

- LXWXH: 148X87X226 CM
- WEIGHT STACK : 220 LBS



## BR13

### LEG EXTENSION

- LXWXH: 129X105X163 CM
- WEIGHT STACK : 220 LBS



## BR14

### SEATED LEG CURL

- LXWXH: 127X103X163 CM
- WEIGHT STACK : 220 LBS



## BR15

### PRONE LEG CURL

- LXWXH: 150X95X140 CM
- WEIGHT STACK : 220 LBS



## BR24

### DIP / CHIN ASSIST

- LXWXH: 120X110X220 CM
- WEIGHT STACK : 220 LBS



## BR25

### SEATED LEG CURL / LEG EXTENSION

- LXWXH: 140X86X140 CM
- WEIGHT STACK : 220 LBS



## BR26

### TRICEP / BICEP

- LXWXH: 121X105X140 CM
- WEIGHT STACK : 190 LBS



## BR27

### ABDUCTOR / ADDUCTOR

- LXWXH: 150X70X140 CM
- WEIGHT STACK : 175 LBS



## BR28

### PRONE LEG CURL / LEG EXTENSION

- LXWXH: 154X105X163 CM
- WEIGHT STACK : 220 LBS



## BR29

### MULTI PRESS

- LXWXH: 188X140X163 CM
- WEIGHT STACK : 220 LBS



## BR30

### LAT PULL / SEATED ROW

- LXWXH: 215X85X226 CM
- WEIGHT STACK : 220 LBS



## BR33

### BACK EXTENSION / ABDOMINAL

- LXWXH: 116X104X140 CM
- WEIGHT STACK : 190 LBS



## BR35

### ROWING MACHINE

- LXWXH: 128X86X191 CM
- WEIGHT STACK : 220 LBS



## BR36

### FUNCTIONAL TRAINER

- LXWXH: 105X195X230 CM
- WEIGHT STACK : 220 LBS X 2

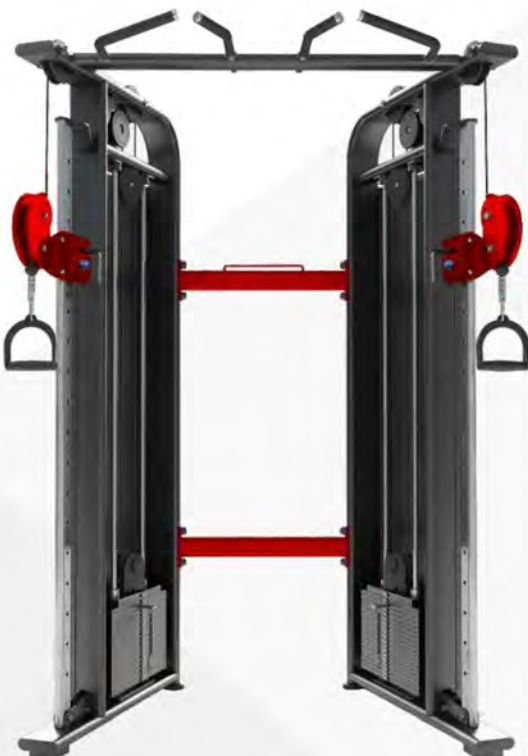

## BR37

### SMITH MACHINE

- LXWXH: 142X221X236 CM
- COUNTER BALANCED



# CONQUER LINE UNIQUE FEATURES

- ◇ Ergonomic style double stitching upholstery
- ◇ Comfortable foam padding

◇ Oval tube main frame of size 50\*120mm

◇ Shroud cover made of steel for maximum safety

◇ Round rubber foot protector for stable grip

◇ Aluminum handle caps

◇ Hydraulic seat adjustment system

◇ Oval tube base frame of size 50\*100mm



## PS2001

### PRONE LEG CURL

- LXWXH: 165X96X153 CM
- WEIGHT STACK : 210 LBS



## PS2002

### LEG EXTENSION

- LXWXH: 156X103X153 CM
- WEIGHT STACK : 240 LBS



## PS2003

### LEG PRESS

- LXWXH: 209X106X153 CM
- WEIGHT STACK : 240 LBS



## PS2006

### SHOULDER PRESS

- LXWXH: 175X135X153 CM
- WEIGHT STACK : 240 LBS



## PS2007

### PEC FLY / REAR DELT

- LXWXH: 186X131X202 CM
- WEIGHT STACK : 240 LBS



## PS2008

### CHEST PRESS

- LXWXH: 148X105X181 CM
- WEIGHT STACK : 240 LBS



## PS2009

### DIP / CHIN ASSIST

- LXWXH: 139X122X235 CM
- WEIGHT STACK : 195 LBS



## PS2021

### ABDUCTOR / ADDUCTOR

- LXWXH: 161X75X153 CM
- WEIGHT STACK : 200 LBS



## PS2033

### LONG PULL

- LXWXH: 180X133X187 CM
- WEIGHT STACK : 240 LBS



## PS2034

### VERTICAL ROW

- LXWXH: 149X129X151 CM
- WEIGHT STACK : 210 LBS



## PS2084

### MULTI PRESS

- LXWXH: 181X146X153 CM
- WEIGHT STACK : 240 LBS



## PS2085

### LAT PULL / SEATED ROW

- LXWXH: 197X114X224 CM
- WEIGHT STACK : 240 LBS



## PS2086

### SEATED LEG CURL / EXTENSION

- LXWXH: 145X102X153 CM
- WEIGHT STACK : 240 LBS



## PS2087

### BICEP / TRICEP

- LXWXH: 133X106X153 CM
- WEIGHT STACK : 240 LBS



# BH SERIES UNIQUE FEATURES

- ◇ Main frame: Flat Oval Tube (50 120\*2.5T)
- ◇ Press arm: Round tube (60/50\*3.0T)  
Flat Oval Tube (40\*80\*3.0T)
- ◇ Connecting assembly: Flat Oval Tube (50\*120\*2.5T)

- ◇ Material : Hollow stainless steel. Surface polishing, refined through several processes to ensure low noise, super wear-resistant, non-deformation, good smoothness, brighter and more durable. It does not get rust after 24h of salt atmosphere test.

- ◇ The cushion is made of PU and it's hardness is designed according to the principles of ergonomics and controlled to be around HBS-65±5, which assures that it's suitable for almost all users.
- ◇ The upholstery leather does not peel off or fade after getting rubbed 8000 times with a 500g weight

- ◇ PVC sticker, backed with 3M high viscosity adhesive, moisture resistant and corrosion resistant.

- ◇ Max load : 1000kg  
It has passed a 100,000 round endurance test.

- ◇ All steel (20# alloy steel) accurate weight.

- ◇ Material: PVC  
Process: one forming technology

- ◇ High-Quality domestic bearing



## BH3501

### CHEST PRESS

- LXWXH: 123X140X164 CM
- WEIGHT STACK : 220 LBS



## BH3502

### LAT PULLDOWN

- LXWXH: 144X128X222 CM
- WEIGHT STACK : 220 LBS



## BH3503

### ARM CURL

- LXWXH: 133X102X164 CM
- WEIGHT STACK : 175 LBS



## BH3505

### LEG EXTENSION

- LXWXH: 151X104X164 CM
- WEIGHT STACK : 220 LBS



## BH3506

### SEATED LEG CURL

- LXWXH: 170X108X164 CM
- WEIGHT STACK : 175 LBS



## BH3508

### ABDUCTOR / ADDUCTOR

- LXWXH: 80X167X164 CM
- WEIGHT STACK : 175 LBS



## BH3510

### LEG PRESS

- LXWXH: 223X108X164 CM
- WEIGHT STACK : 265 LBS



## BH3512

### SHOULDER PRESS

- LXWXH: 140X166X164 CM
- WEIGHT STACK : 175 LBS



## BH3515

### PEC FLY / REAR DELT

- LXWXH: 140X113X201 CM
- WEIGHT STACK : 175 LBS



## BH3517

### TRICEP PRESS

- LXWXH: 94X101X164 CM
- WEIGHT STACK : 220 LBS



## BH3519

### VERTICAL ROW

- LXWXH: 159X121X164 CM
- WEIGHT STACK : 220 LBS



## BH3520

### DIP / CHIN ASSIST

- LXWXH: 113X116X242 CM
- WEIGHT STACK : 220 LBS



## BH3521

### PRONE LEG CURL

- LXWXH: 154X102X164 CM
- WEIGHT STACK : 175 LBS



## BH3522

### LAT PULL / SEATED ROW

- LXWXH: 155X149X221 CM
- WEIGHT STACK : 220 LBS



## BH3524

### LATERAL RAISE

- LXWXH: 116X129X164 CM
- WEIGHT STACK : 175 LBS



## BH3528

### LEG EXTENSION / LEG CURL

- LXWXH: 155X112X164 CM
- WEIGHT STACK : 175 LBS



## BH3529

### MULTI PRESS

- LXWXH: 157X142X164 CM
- WEIGHT STACK : 175 LBS



## BH3533

### BICEP / TRICEP

- LXWXH: 144X104X164 CM
- WEIGHT STACK : 175 LBS



## BH3535

### SEATED HORIZONTAL PULLEY

- LXWXH: 156X89X164 CM
- WEIGHT STACK : 220 LBS



## BH3555

### 45° LEG PRESS

- LXWXH: 237X161X147 CM



## BH3559

### SUPER SQUAT

- LXWXH: 223X150X170 CM



## BH3560

### 45° LEG PRESS / HACK SQUAT

- LXWXH: 226X158X157 CM



## BH3570

### FTSM

- Functional Trainer with Smith Machine
- LXWXH: 246X118X226 CM
- WEIGHT STACK : 175 LBS X 2



## **BH3575**

### FUNCTIONAL TRAINER

- LXWXH : 162x117x235 CM.
- Weight Stack:220 LBS x 2.



## **BH3580**

### CHEST PRESS

- LXWXH: 179X136X101 CM



## **BH3581**

### ROW

- LXWXH: 175X129X109 CM



## BH3582

### INCLINE CHEST PRESS

- LXWXH: 198X114X113 CM



## BH3583

### FID WARRIOR BENCH

- Comes with adjustable flat, incline & decline positions
- Both front & back seats can be adjusted
- Easy to read marking on chrome plate
- Comfortable PU moulded embroidered seats
- Heavy duty frame structure with maximum user weight of 130 kg



## BH3585

### FUNCTIONAL TRAINER

- LXWXH: 160X117X235 CM
- Weight Stack : 220 Lbs X 2



**VIVA**<sup>®</sup>  
**FITNESS**

**# PushYourself**



# E SERIES UNIQUE FEATURES



## E5001

### PRONE LEG CURL

- LXWXH: 152X99X135 CM
- WEIGHT STACK : 210 LBS



## E5002

### LEG EXTENSION

- LXWXH: 130X99X135 CM
- WEIGHT STACK : 240 LBS



## E5003

### SEATED LEG PRESS

- LXWXH: 190X110X162 CM
- WEIGHT STACK : 255 LBS



## E5005

### LATERAL RAISE

- LXWXH: 91X115X150 CM.
- WEIGHT STACK : 120 LBS



## E5006

### SHOULDER PRESS

- LXWXH: 185X122X132 CM
- WEIGHT STACK : 240 LBS



## E5007

### PEC FLY / REAR DELT

- LXWXH: 124X99X211 CM
- WEIGHT STACK : 240 LBS



## E5008

### CHEST PRESS

- LXWXH: 132X130X135 CM
- WEIGHT STACK : 240 LBS



## E5009

### DIP CHIN

- LXWXH: 155X137X236 CM
- WEIGHT STACK : 200 LBS



## E5013

### INCLINE CHEST PRESS

- LXWXH: 185X122X132 CM
- WEIGHT STACK : 240 LBS



## E5023

### SEATED LEG CURL

- LXWXH: 165X94X135 CM
- WEIGHT STACK : 240 LBS



## E5030

### BICEP CURL

- LXWXH: 119X89X135 CM
- WEIGHT STACK : 140 LBS



## E5033

### LONG PULL

- LXWXH: 282X109X236 CM
- WEIGHT STACK : 310 LBS



## E5034

### VERTICAL ROW

- LXWXH: 155X132X160 CM
- WEIGHT STACK : 210 LBS



## E5035

### LAT PULL DOWN

- LXWXH: 185X109X234 CM
- WEIGHT STACK : 240 LBS



## E3046

### STANDING MULTI FLIGHT

- LXWXH: 142X89X200 CM
- WEIGHT STACK : 175 LBS



## E5084

### MULTI PRESS

- LXWXH: 200X135X162 CM
- WEIGHT STACK : 240 LBS



## E5086

LEG CURL /  
LEG EXTENSION

- LXWXH: 140X120X162 CM
- WEIGHT STACK : 240 LBS



## E5087

BICEP / TRICEP

- LXWXH: 140X120X162 CM
- WEIGHT STACK : 140 LBS



## E5088

ABDOMINAL /  
BACK EXTENSION

- LXWXH: 131X99X162 CM
- WEIGHT STACK : 240 LBS



## E5089

ABDUCTOR / ADDUCTOR

- LXWXH: 155X90X162 CM
- WEIGHT STACK : 210 LBS



# E3016

## CABLE CROSSOVER

- LXWXH: 447X109X231 CM
- WEIGHT STACK : 220 LBS X 2



# E1017

## FUNCTIONAL TRAINER

- LXWXH: 105X176X225 CM
- WEIGHT STACK : 220 LBS X 2



## E5200

### ADJUSTABLE HI/LO PULLEY

- LXWXH : 99X124X227 CM
- WEIGHT STACK : 220 LBS



## E5202

### 4 STATION JUNGLE GYM

- Multiple exercise function - Lat Pulldown, Mid row  
Pec fly / Rear delt & Hi-Lo Pulley
- LXWXH : 350X228X227 CM
- WEIGHT STACK : 220 LBS X 4



## E5203

### CABLE CROSSOVER

- E5200+E5200
- WEIGHT STACK : 220 LBS X 2



## E5204

### 5 STATION JUNGLE GYM

- E5200+E5202
- WEIGHT STACK : 220 LBS X 5



## E5205

### 4 STATION JUNGLE GYM

- Multiple exercise function - Leg extension / Curl, Leg press Multi press & Hi-Lo Pulley.
- LXWXH : 350X260X227 CM
- WEIGHT STACK : 220 LBS X 3 & 240 LBS x 1



## E5206

### 5 STATION JUNGLE GYM

- E5200+E5205
- WEIGHT STACK : 220 LBS X 4 & 240 LBS x 1

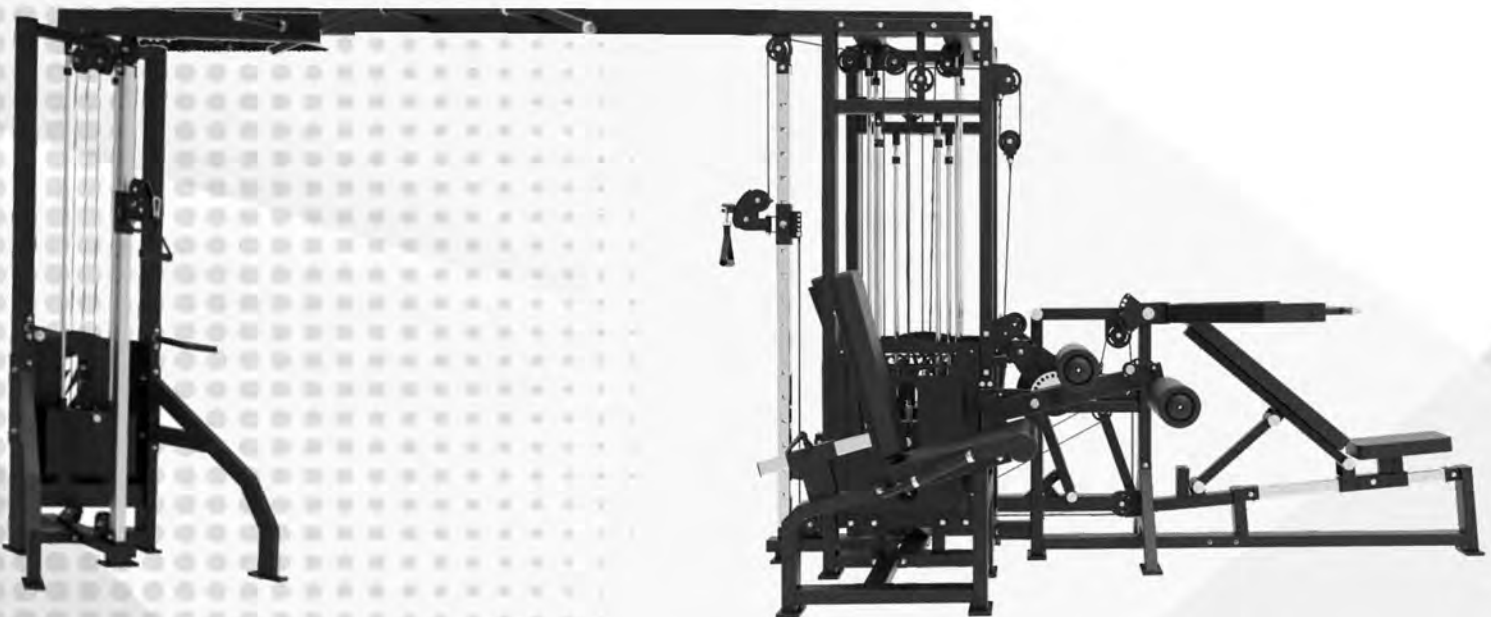

# E5207

## 8 STATION JUNGLE GYM

- E5202+E5205
- LXWXH : 760X350X227 CM
- WEIGHT STACK : 220 LBS X 7 & 240 LBS X 1



## E1080

### AB COASTER

- LXWXH : 185X72X145 cm
- Maximum user weight : 150 kg.



## E1082

### AB COASTER

- LXWXH : 164x78x146 CM.
- Maximum user weight : 180 kg.



## E3036

### FLAT BENCH

- LXWXH: 141X68X42 CM



## E3037

### ADJUSTABLE AB BENCH

- LXWXH: 164X68X99 CM



## E3038

### MULTI PURPOSE BENCH

- LXWXH: 106X68X90 CM



## E3039

### ADJUSTABLE BENCH

- LXWXH: 138X68X69 CM



## E3041

### OLYMPIC DECLINE BENCH

• LXWXH: 209X170X122 CM



## E3042

### OLYMPIC INCLINE BENCH

• LXWXH: 196X170X140 CM



## E3043

### OLYMPIC FLAT BENCH

• LXWXH: 174X170X122 CM



## E3044

### SEATED PREACHER CURL

• LXWXH: 113X84X88 CM



## E3045

### HYPER EXTENSION

• LXWXH: 121X89X67 CM



## E3047

### DIP / VERTICAL KNEE RAISE

• LXWXH: 127X71X160 CM



## E3050

### SQUAT RACK

- LXWXH: 173X170X178 CM



## E3055

### PLATE LOADED LEG PRESS

- LXWXH: 217X161X126 CM



## E3056

### PLATE LOADED LEG PRESS

- LXWXH: 221X63X135 CM



## E3057

### PLATE LOADED HACK SQUAT

- LXWXH: 224X163X126 CM



## E3058

### INCLINE LINEAR ROW

- LXWXH: 171X91X121 CM



## E3061

### T BAR

- LXWXH : 185x79x119 CM



## E3062

### SEATED CALF

- LXWXH: 150X71X99 CM



## E3063

### SMITH MACHINE

- LXWXH: 142X221X236 CM
- COUNTER BALANCED



## E3065

### SUPER SQUAT

- LXWXH: 185X79X119 CM



## E 3066

### ABDOMINAL TRAINER

- LXWXH: 129X61X154



## E3092

### BOOTY MACHINE

- LXWXH: 201X163X147 CM.



## E3093

### GLUTE BUILDER

- LXWXH: 140X191X353 CM



## E6234

### REVERSE HYPER EXTENSION

- LXWXH: 155X140X123 CM



## E6254

### HALF RACK WITH WOODEN PLATFORM

- LXWXH: 139X152X235 CM
- Thickness of wooden platform is 30mm and rubber pad under wooden platform is 20mm
- Thickness of rubber matt on sides is 50mm



## E6255

### BELT SQUAT

- LXWXH: 194X148X133 CM



## E6256

### PENDULUM SQUAT

- Comes with adjustable footplate angles
- LXWXH: 243X141X167 CM



## E6257

### BELT HIP THRUST

- LXWXH: 151X157X90 CM



## E6258

### TRICEP EXTENSION / DIP

- Adjustable seat rest for different height
- LXWXH: 123X81X119 CM



## E6259

### POWER LIFTING BENCH

- Seamless height adjustment.
- Stable structure & exceptional safety for professional use.
- Comes with lever-arm jack system for quick adjustments.
- Removable bench & spotters.
- LXWXH : 208x177x135 CM.



# SS SERIES UNIQUE FEATURES

✦ Instructive - simple, step-by-step instructions and training tips help users get the most out of their exercise. Makes exercise easy and enjoyable

✦ Steel weight stack cover for user safety and machine protection.

✦ Seats made from integrated foam to give perfect support and avoid de-shaping even after long use.

✦ Aircraft spec 5.7mm American LOOS cable with 3,500 lbs breaking strength. End fittings tested to 200,000 cycles using full weight stack.  
✦ Pure steel weight stacks.  
✦ D: 106.2mm powerful nylon pulley in full alignment with cable for lifetime use.

✦ Classic frame design for professional training  
✦ Tubing: 3mm, 50mm by 100mm flat oval tubing  
✦ Finish: Powder-coated painting color for premium look and also for protection from rusting.

✦ Compact - space efficient design requires minimal floor space.  
✦ Rubber grip prevent from being slipped.

## SS01

### CHEST PRESS

- LXWXH : 138X113X161 CM
- Weight Stack : 220 lbs



## SS02

### SHOULDER PRESS

- LXWXH : 140X135X161 CM
- Weight Stack : 220 lbs



## SS03

### BICEP CURL

- LXWXH : 117X119X161 CM
- Weight Stack : 175 lbs



## SS05

### MULTI PRESS

- LXWXH : 189X123X161 CM
- Weight Stack : 220 lbs



## SS06

### PEC FLY / REAR DELT

- LXWXH : 162X105X200 CM
- Weight Stack : 220 lbs



## SS07

### LAT PULL / SEATED ROW

- LXWXH : 151X142X226 CM
- Weight Stack : 220 lbs



## SS08

### LOW ROW

- LXWXH : 175X116X180 CM
- Weight Stack : 220 lbs



## SS09

### ASSISTED CHIN DIP

- LXWXH : 165X118X229 CM
- Weight Stack : 220 lbs



## SS11

### ABDUCTOR / ADDUCTOR

- LXWXH : 155X131X161 CM
- Weight Stack : 175 lbs



## SS12

### SEATED LEG CURL

- LXWXH : 155X127X161 CM
- Weight Stack : 220 lbs



## SS13

### PRONE LEG CURL

- LXWXH : 169X115X161 CM
- Weight Stack : 220 lbs



## SS14

### LEG EXTENSION

- LXWXH : 134X127X161 CM
- Weight Stack : 220 lbs



## SS15

### SEATED LEG CURL / LEG EXTENSION

- LXWXH : 139X127X161 CM
- Weight Stack : 220 lbs



## SS17

### LAT PULL DOWN

- LXWXH : 124X142X224 CM
- Weight Stack : 220 lbs



## SS18

### ROTARY TORSO

- LXWXH : 131X107X161 CM
- Weight Stack : 175 lbs



## SS20

### PRONE LEG CURL / LEG EXTENSION

- LXWXH : 115X113X161 CM
- Weight Stack : 220 lbs



# TITAN SERIES UNIQUE FEATURES

The Titan Series features a luxurious golden finish that is truly unique, this design not only stands out but also exudes elegance and sophistication. It enhances the overall ambience of your gym and provides an exceptional visual and training experience for users. We designed an ergonomic handgrip with a textured surface to distribute the load more evenly, making push and pull movements more safe and effective.

Superior multi-link structure provides stable and uniform resistance throughout the entire range of motion, ensuring more efficient workouts. Mimics the natural movement trajectory of the human body, reducing stress on joints and soft tissues, thereby achieving safety and comfort during training.



## TI 3001

### CHEST PRESS

- LXWXH : 167X149X183 CM
- MAX WEIGHT CAPACITY:300Kg/660lbs



## TI 3002

### PULL DOWN

- LXWXH : 209X147X204 CM
- MAX WEIGHT CAPACITY:300Kg/660lbs



## TI 3003

### SHOULDER PRESS

- LXWXH : 155X183X171 CM
- MAX WEIGHT CAPACITY:300Kg/660lbs



## TI 3004

### LOW ROW

- LXWXH : 150X147X187 CM
- MAX WEIGHT CAPACITY:300Kg/660lbs



## TI 3005

### INCLINE CHEST PRESS

- LXWXH : 183X148X180 CM
- MAX WEIGHT CAPACITY:300Kg/660Lbs



## TI 3006

### LEG PRESS

- LXWXH : 256X168X158 CM
- MAX WEIGHT CAPACITY:400Kg/880Lbs



## TI 3008

### REAR KICK

- LXWXH : 160X140X190 CM
- MAX WEIGHT CAPACITY:150Kg/330Lbs



## TI 3007

### ROW

- LXWXH : 167X135X134 CM
- MAX WEIGHT CAPACITY:300Kg/660Lbs



## TI 3023

### BICEP CURL

- LXWXH : 161X118X103 CM
- MAX WEIGHT CAPACITY:300Kg/660Lbs



## TI 3024

### SEATED DIP

- LXWXH : 181X170X105 CM
- MAX WEIGHT CAPACITY:300Kg/660Lbs



## TI 3025

### ISO LATERAL LEG EXTENSION

- LXWXH : 152X128X117 CM
- MAX WEIGHT CAPACITY:300Kg/660Lbs



## TI 3050

### WIDE CHEST PRESS

- LXWXH : 169X146X187 CM
- MAX WEIGHT CAPACITY:300Kg/660Lbs



## TI 3064

### PULLOVER

- LXWXH : 214X163X150 CM
- MAX WEIGHT CAPACITY:300Kg/660Lbs



## TI 3066

### HIP THRUST

- LXWXH : 192X134X95 CM
- MAX WEIGHT CAPACITY:300Kg/660Lbs



# PL SERIES UNIQUE FEATURES

Easy to use, neat appearance, the PL line is a high quality commercial plate loaded series. The user-friendly design makes working out more simple, efficient, comfortable and satisfying.



## PL4001

### CHEST PRESS

- LXWXH : 195X154X171 CM.
- Max Weight Capacity : 300 kg / 660 lbs



## PL4002

### PULL DOWN

- LXWXH : 160X145X196 CM.
- Max Weight Capacity : 300 kg / 660 lbs



## PL4003

### SHOULDER PRESS

- LXWXH : 176X155X148 CM.
- Max Weight Capacity : 300 kg / 660 lbs



## PL4004

### LOW ROW

- LXWXH : 178X143X165 CM.
- Max Weight Capacity : 300 kg / 660 lbs



## PL4005

### INCLINE CHEST PRESS

- LXWXH : 152X191X177 CM.
- Max Weight Capacity : 300 kg / 660 lbs



## PL4007

### ROW

- LXWXH : 182X150X132 CM.
- Max Weight Capacity : 300 kg / 660 lbs



## PL4008

### DECLINE CHEST PRESS

- LXWXH : 192X121X156 CM.
- Max Weight Capacity : 300 kg / 660 lbs



## PL4009

### POWER RACK

- LXWXH : 204X116X228 CM



## PL4011

### FID BENCH

- LXWXH : 136X68X129 CM.



## PL4014

### HAFL RACK

- LXWXH : 203X116X227 CM.



## PL4017

### SEATED CALF

- LXWXH : 149X78X84 CM.
- Max Weight Capacity : 150 kg / 330 lbs



## PL4020

### LEG PRESS

- LXWXH : 250X174X154 CM.
- Max Weight Capacity : 400 kg / 880 lbs



## PL4023

### BICEP CURL

- LXWXH : 140X104X120 CM.
- Max Weight Capacity : 300 kg / 660 lbs



## PL4024

### TRICEP DIP

- LXWXH : 173X158X120 CM.
- Max Weight Capacity : 300 kg / 660 lbs



## PL4025

### LEG EXTENSION

- LXWXH : 170X128X122 CM.
- Max Weight Capacity : 120 kg / 264 lbs



## PL4026

### STANDING LEG CURL

- LXWXH : 170X128X122 CM.
- Max Weight Capacity : 120 kg / 264 lbs



## PL4027

### BARBELL RACK

- LXWXH : 94X91X151 CM.



## PL4028

### FLAT BENCH PRESS

- LXWXH : 173X191X131 CM.



## PL4029

### INCLINE BENCH PRESS

- LXWXH : 205X173X131 CM.



## PL4030

### DECLINE BENCH PRESS

- LXWXH : 231X173X131 CM.



## PL4036

### AB BENCH

- LXWXH : 112X143X162 CM.
- Max Weight Capacity : 300 kg / 660 lbs



## PL4041

### SUPER OLYMPIC BENCH

- LXWXH : 231X173X131 CM.



## PL4050

### HIP THRUSTER

- LXWXH : 170X104X84 CM.
- Max Weight Capacity : 300 kg / 660 lbs



## PL4055

HALF RACK WITH  
WOODEN PLATFORM

- LXWXH : 140X110X230 CM.



## PL4065

45° ISO LATERAL  
LEG PRESS

- Max Weight Capacity : 400 kg / 880 lbs



## JPL302

### SHOULDER PRESS

- LXWXH : 129X128X146 CM
- MAX WEIGHT CAPACITY : 250Kg/550Lbs



## JPL303

### CHEST PRESS

- LXWXH : 122X141X164 CM
- MAX WEIGHT CAPACITY : 250Kg/550Lbs



## JPL304

### PULL DOWN

- LXWXH : 112X138X124 CM
- MAX WEIGHT CAPACITY : 250Kg/550Lbs



## JPL305

### ROW

- LXWXH : 118X139X124 CM
- MAX WEIGHT CAPACITY : 250Kg/550Lbs



## JPL306

### LOW ROW

- LXWXH : 120X122X163 CM
- MAX WEIGHT CAPACITY : 250Kg/550Lbs



## JPL307

### LEG PRESS

- LXWXH : 145X210X135 CM
- MAX WEIGHT CAPACITY : 300Kg/660Lbs



## JPL308

### INCLINE CHEST PRESS

- LXWXH : 153X103X164 CM
- MAX WEIGHT CAPACITY : 250Kg/550Lbs



## JPL310

### REAR KICK

- LXWXH : 111X143X164 CM
- MAX WEIGHT CAPACITY : 250Kg/550Lbs



## JPL312

### TRICEP DIP

- LXWXH : 147X154X86 CM
- MAX WEIGHT CAPACITY : 250Kg/550Lbs



## JPL313

### BICEP CURL

- LXWXH : 106X139X101 CM
- MAX WEIGHT CAPACITY : 250Kg/550Lbs



## JPL314

### STANDING LEG CURL

- LXWXH : 144X117X142 CM
- MAX WEIGHT CAPACITY : 250Kg/550Lbs



## JPL315

### LEG EXTENSION

- LXWXH : 124X126X117 CM
- MAX WEIGHT CAPACITY : 250Kg/550Lbs



## JPL316

### LINEAR LEG PRESS

- LXWXH : 270X157X150 CM
- MAX WEIGHT CAPACITY : 400Kg/880Lbs



## JPL318

### INCLINE PEC FLY

- LXWXH : 163X164X110 CM
- MAX WEIGHT CAPACITY : 250Kg / 550Lbs



## JPL320

### CHEST PRESS / LAT PULLDOWN

- LXWXH : 215X169X203 CM
- MAX WEIGHT CAPACITY : 250Kg / 550Lbs



## JPL322

### LUNGE / DEADLIFT / SHRUGS

- LXWXH : 162X154X87 CM
- MAX WEIGHT CAPACITY : 400Kg/880Lbs



## JPL323

### ISO FID BENCH

- LXWXH : 188X201X175 CM
- MAX WEIGHT CAPACITY : 160Kg / 350Lbs



## JPL329

### SMITH SQUAT COMBO

- WITH COUNTER BALANCE MACHINE
- LXWXH : 200X142X218 CM



## JPL327

### POWER RACK / SMITH MACHINE

- LXWXH : 183X221X219 CM



## JPL328

### POWER RACK / SMITH MACHINE

- WITH COUNTER BALANCE
- LXWXH : 183X221X219 CM



## JPL333

### STANDING HIP THRUST

- LXWXH : 117X124X152 CM.



## JPL334

### FOREARM JUNGLE

- LXWXH : 168X160X133 CM.



## JPL335

### FOREARM JUNGLE WITH ARM WRESTLING



## JPL337

### PULLOVER

- LXWXH : 172X166X150 CM.
- MAX WEIGHT CAPACITY : 250Kg / 550Lbs



## JPL338

### PULL DOWN

- LXWXH : 173X170X206 CM.
- MAX WEIGHT CAPACITY : 250Kg / 550Lbs



## JPL339

### ROWING MACHINE

- LXWXH : 162X172X113 CM.
- MAX WEIGHT CAPACITY : 250Kg / 550lbs



## JPL340

### SHOULDER PRESS

- LXWXH : 186X146X192 CM.
- MAX WEIGHT CAPACITY : 250Kg / 550lbs



## JPL341

### PRECISION CHEST PRESS

- LXWXH : 146X206X168 CM.
- MAX WEIGHT CAPACITY : 250Kg / 550lbs



## JPL342

### 3D SMITH HIP THRUST

- LXWXH : 208X151X138 CM.
- MAX WEIGHT CAPACITY : 250Kg / 550lbs



## JPL 343

### VERTICAL CHEST PRESS

- LXWXH : 158X101X184 CM.
- MAX WEIGHT CAPACITY : 250Kg / 550Lbs



## JPL 344

### OVERHEAD PRESS

- LXWXH : 143X97X143 CM.
- MAX WEIGHT CAPACITY : 250Kg / 550Lbs



## JPL 345

### LAT PULL DOWN

- LXWXH : 205X90X232 CM.
- MAX WEIGHT CAPACITY : 300Kg / 660Lbs



## JPL 346

### INCLINE PRESS

- LXWXH : 173X96X134 CM.
- MAX WEIGHT CAPACITY : 250Kg / 550Lbs



## JPL347

### ADJUSTABLE T-BAR

- LXWXH : 210X91X133 CM.
- MAX WEIGHT CAPACITY : 250Kg / 550Lbs



## JPL348

### MULTI LOW ROW / DEADLIFT

- LXWXH : 176X139X146 CM.
- MAX WEIGHT CAPACITY : 250Kg / 550Lbs



## JPL349

### BI-LATERAL REVERSE PULL DOWN

- LXWXH : 162X119X200 CM.
- MAX WEIGHT CAPACITY : 300Kg / 660Lbs



## JPL350

### HIP TRAINER

- LXWXH : 174X148X80 CM.



## BEAST 21

OLYMPIC FLAT BENCH

• LXWXH : 164X153X119 CM



## BEAST 22

OLYMPIC INCLINE BENCH

• LXWXH : 184X153X140 CM



## BEAST 23

OLYMPIC DECLINE BENCH

• LXWXH : 200X153X119 CM



## BEAST 24

HYPER EXTENSION

• LXWXH : 137X97X97 CM



## BEAST 26

### SEATED CALF

- LXWXH : 145X58X94 CM



## BEAST 27

### AB BENCH

- LXWXH : 182X99X103 CM



## BEAST 30

### FLAT BENCH

- LXWXH : 146X73X44 CM



## BEAST 29

### MULTI AB BENCH

- LXWXH : 172X63X91 CM



## BEAST 31

### MULTI ADJUSTABLE BENCH

- Option of Flat, Incline & Decline position.
- LXWXH : 178X61X135 CM



## BEAST 32

### UTILITY BENCH

- LXWXH : 108X53X90 CM



## BEAST 33

### FID BENCH

- Comes with adjustable flat, incline & decline positions
- Both front & back seats can be adjusted
- Easy to read marking on chrome plate
- Comfortable PU moulded seats
- Heavy duty frame structure with maximum user weight of 140 kg



## BEAST 35

### 45° LEG PRESS

- LXWXH : 249X155X155 CM

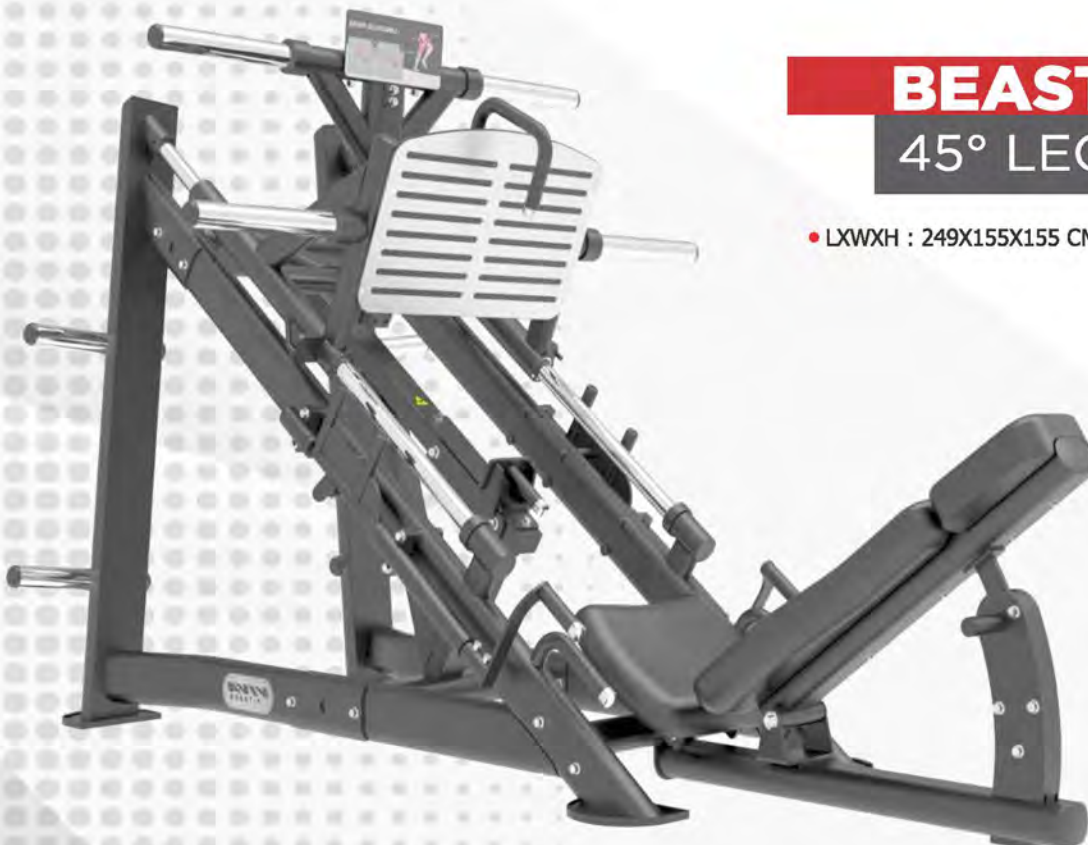

## BEAST 37

### PLATE TREE

LXWXH : 96X63X120 CM.



## BEAST 38

### PREACHER CURL BENCH

• LXWXH : 113X84X88 CM



## Beast 39

### Vertical knee raise / Dip stand

• LXWXH : 119X77X136 CM



## BEAST 40

### DUMBBELL RACK

- LXWXH : 209X81X83 CM
- Can hold 10 pairs.



## BEAST 41

### 3 TIER DUMBBELL RACK

- LXWXH : 213X63X98 CM
- Can hold 15 pairs.



## **FL6002**

### **PREACHER CURL BENCH**

- Paint Finish : Electrostatic Powder Coating
- Seats : Tear resistant leatherite
- Pipe Size : 100x50x2.5 mm
- LXWXH : 117X75X90 CM



## **FL6005**

### **SEATED CALF RAISE**

- Paint Finish : Electrostatic Powder Coating
- Seats : Tear resistant leatherite
- Pipe Size : 100x50x2.5 mm
- LXWXH : 132X67X91 CM



## **FL6007**

### **HYPER EXTENSION**

- Paint Finish : Electrostatic Powder Coating
- Seats : Tear resistant leatherite
- Pipe Size : 100x50x2.5 mm
- LXWXH : 125X68X90 CM



## **FL6009**

### **FLAT BENCH**

- Paint Finish : Electrostatic Powder Coating
- Seats : Tear resistant leatherite
- Pipe Size : 100x50x2.5 mm
- LXWXH : 128X60X49 CM



## FL6010

### VERTICAL KNEE RAISE / DIP STAND

- Paint Finish : Electrostatic Powder Coating
- Seats : Tear resistant leatherite
- Pipe Size : 100x50x2.5 mm
- LXWXH : 109X75X158 CM



## FL6011

### MULTI ADJUSTABLE BENCH

- Flat / Incline / Decline position
- Paint Finish : Electrostatic Powder Coating
- Seats : Tear resistant leatherite
- Pipe Size : 100x50x2.5 mm
- LXWXH : 158X54X135 CM



## FL6012

### DUMBBELL RACK

- Paint Finish : Electrostatic Powder Coating
- Unique adjustable Lower base in order to accommodate dumbbell of different sizes / types
- Pipe Size : 100x50x2.5 mm
- LXWXH : 208X53X81 CM



## FL6013

### MULTI AB BENCH

- Paint Finish : Electrostatic Powder Coating
- Seats : Tear resistant leatherite
- Pipe Size : 100x50x2.5 mm
- LXWXH : 178X69X92 CM



## **FL6014**

### **OLYMPIC FLAT BENCH**

- Paint Finish : Electrostatic Powder Coating
- Seats : Tear resistant leatherite
- Pipe Size : 100x50x2.5 mm
- LXWXH : 170X159X137 CM



## **FL6015**

### **OLYMPIC INCLINE BENCH**

- Paint Finish : Electrostatic Powder Coating
- Seats : Tear resistant leatherite
- Pipe Size : 100x50x2.5 mm
- LXWXH : 178X159X151 CM



## **FL6016**

### **OLYMPIC DECLINE BENCH**

- Paint Finish : Electrostatic Powder Coating
- Seats : Tear resistant leatherite
- Pipe Size : 100x50x2.5 mm
- LXWXH : 195X159X137 CM



## **FL6018**

### **DUMBBELL RACK**

- Paint Finish : Electrostatic Powder Coating
- Pipe Size : 100x50x2.5 mm
- LXWXH : 200X51X80 CM



## FL6019

### INCLINE T BAR

- Paint Finish : Electrostatic Powder Coating
- Seats : Tear resistant leatherite
- Pipe Size : 100x50x2.5 mm
- LXWXH : 188X99X122 CM



## FL6020

### FID BENCH

- Paint Finish : Electrostatic Powder Coating
- Seats : Tear resistant leatherite
- Pipe Size : 100x50x2.5 mm
- LXWXH : 145X51X132 CM



## FL6021

### SUPER SQUAT

- Paint Finish : Electrostatic Powder Coating
- Seats : Tear resistant leatherite
- Pipe Size : 100x50x2.5 mm
- LXWXH : 190X175X185 CM



## FL6022

### UTILITY BENCH

- Paint Finish : Electrostatic Powder Coating
- Seats : Tear resistant leatherite
- Pipe Size : 100x50x2.5 mm
- LXWXH : 101X81X88 CM



## FL6024

### DELUXE UTILITY STOOL

- Paint Finish : Electrostatic Powder Coating
- Seats : Tear resistant leatherite
- Pipe Size : 100x50x2.5 mm
- LXWXH : 120X81X88 CM



## FL6041

### 4 WAY OLYMPIC BENCH

- Unique Flat / Incline / Decline / Shoulder position
- Paint Finish : Electrostatic Powder Coating
- Seats : Tear resistant leatherite
- Pipe Size : 100x50x2.5 mm
- LXWXH : 167X172X163 CM



## FL6063

### 3 TIER DUMBBELL RACK

- Paint Finish : Electrostatic Powder Coating
- Pipe Size : 100x50x2.5 mm
- LXWXH : 175X81X92 CM



## FL6064

### PLATE TREE

- Paint Finish : Electrostatic Powder Coating
- Pipe Size : 100x50x2.5 mm
- LXWXH : 82X68X133 CM



## FL6033

### HALF RACK

- Paint Finish : Electrostatic Powder Coating
- Pipe Size : 100x50x2.5 mm
- LXWXH : 136X175X245 CM



## FL6043

### HALF RACK WITH PLATFORM

- Paint Finish : Electrostatic Powder Coating
- Pipe Size : 100x50x2.5 mm
- Rack Size : LXWXH : 136X175X245 CM
- Rubber tile thickness : 25mm
- Wooden board thickness : 25mm



## IFHC

### HALF CAGE

- This base system provides the ultimate in safety and exercise variety.
- Self spotting triple chromed bar racking system for safer free weight solo workouts.
- Includes multiple plate holders for convenient racking.
- Adjustable safety spotters accommodates:
- LXWXH : 118X182X209 CM.



## IFHCS

### HALF CAGE SMITH ATTACHMENT

- Optional for IF-HC.
- LXWXH : 195X30X173 CM.



## IFSS

### SQUAT STAND

- Self spotting triple chromed bar racking system for safer solo workouts.
- Angled uprights for better squat and bench exercises.
- Multiple plate holders for convenient storage.
- Adjustable safety spotters
- LXWXH : 123X128X174 CM.



## IFPT

### POWER TOWER

- Contoured arm rests for secure positioning.
- Angled back pad for added comfort.
- Multiple grip positions for easy chin ups, dips, push ups and leg raise.
- LXWXH : 132X61X210 CM.



## IFAAB

### ADJUSTABLE ABDOMINAL BENCH

- Over sized bench padding for maximum comfort.
- Dual transport wheels for easy movement.
- LXWXH : 168X57X115 CM.



## IFAC

### ABDOMINAL CRUNCH

- Fixed decline angle for basic abdominal workout.
- LXWXH : 110X48X58 CM.



## IF45

### 45°HYPEREXTENSION

- Adjustable thigh pads for proper positioning and support.
- 45 degree angle for optimal results.
- Dual transport wheels for easy movement.
- LXWXH : 121X74X77 CM.



## IFSPC

### SEATED PREACHER CURL

- Bar catch design for easy re-racking.
- Adjustable oversized arm pad.
- LXWXH : 102X71X82 CM.



## IFFB

### FLAT BENCH

- Wide base for added safety.
- Dual rear transport wheels for easy movement.
- LXWXH : 130X53X49 CM.



## IFOIB

### INCLINE BENCH

- LXWXH : 156X131X119 CM.



## IFODB

### DECLINE BENCH

- LXWXH : 190X131X115 CM



## IFOB

### OLYMPIC BENCH

- Excellent adjustable uprights.
- Expandable with drop in attachment.  
Options - IF-LEGA & IF-ARMA.
- Fully adjustable decline to shoulder press.
- LXWXH : 144X126X147 CM.



## IFFID

### MULTI PURPOSE BENCH

- Dual rear transport wheels for easy movement.
- Quick and easy seat and back pad adjustments.
- Fully adjustable decline to shoulder press.
- LXWXH : 158X65X52 CM.



## ROBO ARM ECO

### DUAL CABLE CROSSOVER

- STURDY DESIGN
- Weight stack : 230lbs x 2



## FTSM

### FUNCTIONAL TRAINER CUM SMITH MACHINE

- STURDY DESIGN
- Weight stack : 200lbs x 2
- LXWXH : 258X102X248 CM



## KH212

### DUAL TWISTER

- Durable commercial grade construction.
- With Double Ball Bearings.
- Ergonomically Designed Handles.
- LXWXH : 137X47X127 CM.



## KH230

### SKI CORE BALANCE BOARD



## KH260

### GORILLA GRIPPER / WRIST CURL

- Paint Finish : Electrostatic Powder Coating
- Seats : Tear resistant latherite
- Pipe Size : 100x50x2.5 mm
- Weight Stack : 60 KGS
- LXWXH : 58X57X103 CM



## KH271

### SISSY SQUAT

- Sturdy Design.



## KH272

### SISSY SQUAT

- Sturdy Design.



## KH273

### TIBIA TRAINER

- Sturdy Design.



## KH275

### WRIST CURL

- Sturdy Design.
- Weight Stack : 175 lbs



## KH276

### WRIST CURL

- Sturdy Design
- Weight Stack : 110 lbs



## KH280

### WRIST CURL

- Paint Finish : Electrostatic Powder Coating
- Seats : Tear resistant latherite
- Pipe Size : 100x50x2.5 mm
- Weight Stack : 88 LBS
- LXWXH : 47X62X100 CM



## KH285

### STANDING LATERAL RAISE

- Commercial Grade.
- Sturdy Frame.
- Weight stack : 130 LBS.
- LXWXH : 145X81X150 CM



## KH286

### GLUTE HAM DEVELOPER

- Commercial Grade.
- Sturdy Frame.
- LXWXH : 184X112X124 CM



## KH287

### MULTI PURPOSE STORAGE RACK

- Commercial Grade.
- Sturdy Frame.
- Ideal for Dumbbells, Medicine balls, Kettle bells etc.
- LXWXH : 198X63X180 CM



## KH288

### ACCESSORIES RACK



## KH300

### FUNCTIONAL TRAINER

- Comes with double pulley on both sides
- Weight Stack : 100X2 kg
- LXWXH : 85X207X225 CM



## **KH303**

### BARBELL RACK

- Sturdy Design
- LXWXH : 44X44X17 CM
- For 9 rods



## **KH305**

### BARBELL RACK

- Sturdy Design
- For 5 rods



## **KH320**

### BICEP CURL STAND

- Commercial Grade.
- Sturdy Frame.
- Can store upto 6 Olympic hole plates.
- LXWXH : 122X46X73 CM



## **KH321**

### REVOLVING BARBELL RACK

- Can Hold 12 Pcs Barbells.



## **KH322**

### AB MAT



## **KH646**

### TRIPLE STORAGE RACK

- Can store upto 12 barbells, 24 weight plates and 8 pcs kettle bell.



## **KH698**

### LEG PRESS / HACK SQUAT

- LXWXH : 208X92X149 CM



## X75

### FID BENCH

- Durable commercial grade construction.
- Heavy duty frame structure.
- Options of flat, incline & decline position.
- Can be used for multiple exercises.



## X76

### BRIDGE BENCH

- Durable commercial grade construction.
- Heavy duty frame structure.
- Options of flat, incline & decline position.
- Can be used for multiple exercises.



## X100

### MULTI PURPOSE BENCH

- Flat, incline & decline position.
- With preacher curl attachment.
- With leg extension & prone leg curl.



## X150

### 3 WAY OLYMPIC BENCH

- Flat, incline & decline position.
- With smooth & convenient seat adjustment.
- LXWXH : 241X188X142 CM.



## X300

### SMITH MACHINE



## X400

### WALL MOUNTED FOLDABLE SQUAT RACK

- DIMENSIONS : 115X138X230 CMS
- MAXIMUM WEIGHT LOADING CAPACITY : 200 KGS



## X500

### HALF RACK

- DIMENSIONS : 126X180X232 CMS
- MAXIMUM WEIGHT LOADING CAPACITY : 200 KGS



## X600

### FUNCTIONAL RACK WITH LONG PULL

- DIMENSIONS : 154X170X232 CMS
- MAXIMUM WEIGHT LOADING CAPACITY : 120 KGS



## X900

### FTSM

- FUNCTIONAL TRAINER CUM SMITH MACHINE
- DIMENSIONS : 205X147X232 CMS
- WEIGHT STACK OF 80 KG X 2
- MAXIMUM WEIGHT LOADING CAPACITY : 200 KGS



## SAVAGE

### MULTI TRAINER

- FUNCTIONAL TRAINER CUM SMITH MACHINE CUM MULTI GYM
- DIMENSIONS : 180X219X227 CMS
- WEIGHT STACK OF 100 KG X 2
- MAXIMUM WEIGHT LOADING CAPACITY : 200 KGS



## 618LP ENDURANCE

### HEAVY DUTY COMMERCIAL MULTI GYM

- State-of-the-art design with heavy duty steel structure
- 4 station gym with 3 steel weight stacks of 90 Kgs each
- Multiple Exercise Function – Leg press, Shoulder press, Chest press, Lat pull, Seated row and all high / low pulley exercises
- Comfortable seat pads
- All weight stacks attached at right angle for maximum space saving when placed in a corner
- Durable powder coated finish
- Arc cover for protection
- LXWXH : 269X239X216 CM



## 618EC POWER HOUSE

### HEAVY DUTY COMMERCIAL MULTI GYM

- State-of-the-art design with heavy duty steel structure
- 4 station gym with 3 steel weight stacks of 90 Kgs each
- Multiple Exercise Function – Leg extension, Prone leg curl, Shoulder press, Chest press, Lat pull, Seated row and all high / low pulley exercises
- Comfortable seat pads
- All weight stacks attached at right angle for maximum space saving when placed in a corner
- Durable powder coated finish
- Arc cover for protection
- LXWXH : 269X239X216 CM



# 318LP

## MULTI GYM

- Innovative design and ideal for corporate & society use
- Multi station gym with 1 steel weight stacks of 90 Kgs.
- Multiple Exercise Function – Seated bench press, Row, Pull down, Chest clamp, Tricep push down, Standing abdominal curl, Leg extension, Standing leg curl, Standing bicep curl, Golf, Arm extension, Front raise, Shrugs & Leg press.
- Durable powder coated finish
- Comfortable seat pads
- Arc cover for protection
- LXWXH : 219X222X213 CM



# 318MG

## MULTI GYM

- Innovative design and ideal for corporate & society use
- Multi station gym with 1 steel weight stacks of 90 Kgs.
- Multiple Exercise Function – Seated bench press, Row, Pull down, Chest clamp, Tricep push down, Standing abdominal curl, Leg extension, Standing leg curl, Standing bicep curl, Golf, Arm extension, Front raise & Shrugs.
- Durable powder coated finish
- Comfortable seat pads
- Arc cover for protection
- LXWXH : 213X150X213 CM



# 418CA STAR

## COMMERCIAL MULTI GYM

- Innovative design & ideal for corporate or society use.
- 6 station gym with 2 STEEL weight stacks of 70 Kgs each.
- Multiple Exercise Function - Leg extension, Leg press, Hi-Lo pully, Tricep extension, Lat pull, Bicep curl, Pec Dec, Multi press, Abdominal crunch, Bicep curl, Bench press, Vertical knee raise, Chin up & Dips stand etc.
- Durable powder coated finish.
- Comfortable seat pads.
- Arc cover for protection.
- LXWXH : 332X244X230 CM.



# 418BA STELLA

## LIGHT COMMERCIAL MULTI GYM

- Innovative design & ideal for corporate or society use.
- 5 station gym with 2 weight stacks of 65 Kgs each.
- Multiple Exercise Function - Leg extension, Leg press, Hi-Lo pulley, Chin up, Lat pull, Bicep curl, Pec Dec, Multi press, Tricep extension, Abdominal crunch, Bicep curl, Bench press, Vertical knee raise etc.
- Durable power coated finish.
- Comfortable seat pads.
- Arc cover for protection.
- LXWXH : 332X240X230 CM.



# 518LC CHAMPION

## LIGHT COMMERCIAL MULTI GYM

- 4 station gym with 4 weight stacks of 68 Kgs each.
- Exercise Function - Leg press, Chest press, Leg extension, Pec fly, Lat pull, Bicep curl, Rowing etc.
- Durable power coated finish.
- Ergonomic Design / Scientific Biomechanics.
- LXWXH : 250X250X220 CM



# IMPULSE ZONE

Customized Group Functional Training



TOP VIEW



X-SHAPE

PRODUCT DIMENSION  
7489x3139x2446 (mm)  
294.8x123.6x96.3 (in)

# ENERGY 360

WITH ACCESSORIES

● LXWXH : 450X400X250 CM.



8 PCS TRX



9 METERS



MEDICINE BALL  
5 SETS



2 PAIRS



5 SETS



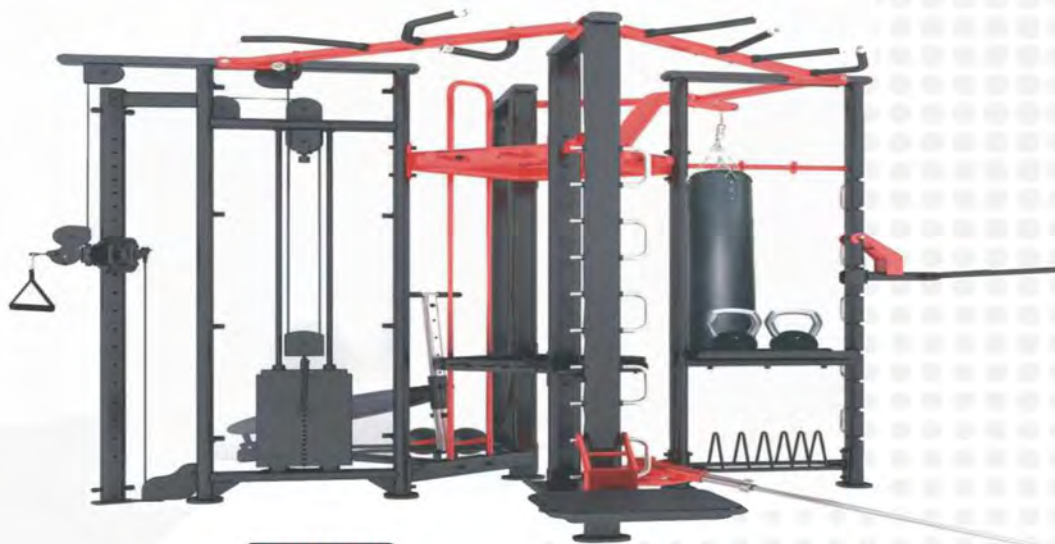

TOP VIEW



### D-SHAPE

PRODUCT DIMENSION  
3235x2855x2400 (mm)  
127.3x112.4x94.4 (in)

## KH308

### SUSPENSION TRAINING RACK

- Sturdy Design.
- LXWXH : 312X206X251 CM.



## WEIGHT LIFTING PLATFORM

- Extra heavy duty steel platform
- Platform size is 8'x6'
- Rubber tile thickness 30mm
- Board thickness 30mm
- Steel frame 50mm



## WEIGHT LIFTING PLATFORM JUNIOR

- Heavy duty steel platform.
- Platform size is 8'x4'
- Rubber tile thickness 25mm
- Board thickness 20mm
- Steel frame 50mm



### RUBBER COATED VIVA POWER FIXED BARBELLS WITH STRAIGHT AND CURL HANDLE BAR

- Made from high grade virgin rubber for long life.
- Dia 30mm and length 100cm.
- Tear proof, soundless & bouncy effect.



AVAILABLE SIZES
KGS
10
15
20
25
30
35
40

### RUBBER COATED VIVA FORCE FIXED BARBELLS WITH STRAIGHT AND CURL HANDLE BAR

- Made from high grade virgin rubber for long life.
- Dia 30mm and length 100cm.
- Tear proof, soundless & bouncy effect.



AVAILABLE SIZES
KGS
10
15
20
25
30
35
40

### VIVA THERMO POWER SOLID DUMBBELLS

- Made from high grade thermoplastic rubber (TPR) for long life.
- Tear proof, soundless & bouncy effect.



AVAILABLE SIZES
KGS
2.5
5
7.5
10
12.5
15
17.5
20
22.5
25
30
35
40
45
50

### VIVA POWER SOLID DUMBBELL

- Made from high grade virgin rubber for long life.
- Tear proof, soundless & bouncy effect.



AVAILABLE SIZES
KGS
2.5
5
7.5
10
12.5
15
17.5
20
22.5
25
27.5
30
35
40
45
50

### VIVA FORCE DUMBBELLS

- Made from high grade rubber compound for long life.
- Tear proof, soundless & bouncy effect.



AVAILABLE SIZES
KGS
2.5
5
7.5
10
12.5
15
17.5
20
22.5
25
27.5
30
35
40
45
50

### HEXAGON DUMBBELL

- Made from rubber for long life.
- Tear proof, soundless & bouncy effect.



AVAILABLE SIZES
KGS
2.5
5
7.5
10
12.5
15
17.5
20
25

## BLACK CHALLENGER

### BUMPER PLATES

- Made from virgin rubber.
- No smell & less bounce.
- Comes with beveled edge & knurled grip.

#### AVAILABLE SIZES

KGS
5
10
15
20
25



## COLOURED

### BUMPER PLATES

- Made from high quality rubber.

#### AVAILABLE SIZES

KGS
5
10
15
20
25



## VIVA FITNESS TPR

### OLYMPIC HOLE PLATES

- Made from high grade thermoplastic rubber for long life.
- Tear proof, soundless & bouncy effect.

#### AVAILABLE SIZES

KGS
1.25
2.5
5
7.5
10
15
20
25



## VIVA LEGACY

### OLYMPIC HOLE PLATES

- Made from high quality MS Steel
- Comes with outer TPU cover to protect flooring

#### AVAILABLE SIZES

KGS
5
7.5
10
15
20
25

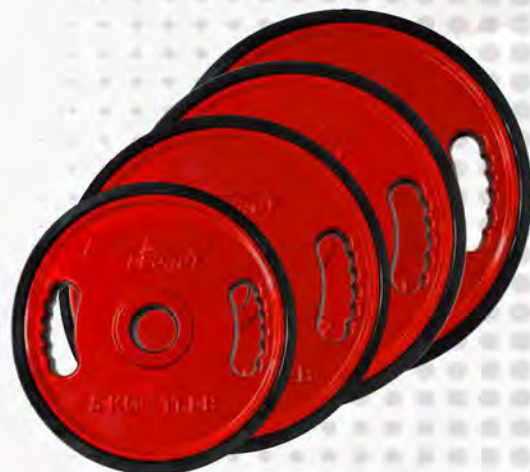

## VIVA POWER

### OLYMPIC HOLE PLATES

- Patented : Unique Anti Roll Design
- Made From Durable And Premium Grade Virgin Rubber
- Aesthetically Designed With Epdm Red Granules
- Ergonomically Designed Grips
- Long Lasting Aluminium Bushes



AVAILABLE SIZES
KGS
1.25
2.5
5
7.5
10
15
20
25

## VIVA FORCE

### OLYMPIC HOLE PLATES

- Made from high grade virgin rubber for long life.
- Tear proof, soundless & bouncy effect



AVAILABLE SIZES
KGS
2.5
5
7.5
10
15
20
25

## NEOPRENE

### KETTLE BELL



AVAILABLE SIZES
KGS
2
4
8
12
16
20
24
28
32

## KH289

### DUMBBELL TO KETTLE BELL CONVERTER

- Recommended for dumbbells below 20 kgs



## IR94088

### STRONGMAN THICK BARBELL

- Unique 50 mm grip bar
- Hard chrome tempered alloy steel
- Max loading : 1600 lbs
- 7.2 ft olympic length.
- Net weight : 20 kgs.



## IR101

### COMPETITION OLYMPIC BAR

- Net weight : 20 kgs.
- 7.2 ft olympic length.
- Flexible barbell made from heat treated Spring Steel.
- High quality nickel chrome finish.
- Comes with 2 bronze bush & 4 needle bearing.
- Shaft diameter : 28mm.
- Sleeve diameter : 50mm.
- Shaft length : 51.5".
- Sleeve length : 15.2"
- Max. load capacity : 907 kg / 2000 Lbs.



## IR106

### COMPETITION OLYMPIC BAR

- Net weight : 20 kgs.
- 7.2 ft olympic length.
- Flexible barbell made from heat treated Spring Steel.
- High quality Camouflage Military green finish.
- Comes with 2 bronze bush & 4 needle bearing.
- Shaft diameter : 28mm.
- Sleeve diameter : 50mm.
- Shaft length : 51.5".
- Sleeve length : 15.2"
- Max. load capacity : 907 kg / 2000 Lbs.



## LEGACY 1001

### HEAVY DUTY OLYMPIC BAR

- Net weight : 20 kgs.
- 7.2 ft Olympic length.
- Metal composition EN 8.
- Coating : Hard Chrome.
- Comes with 2 bronze bush & 4 high quality bearings.
- Shaft diameter : 30mm.
- Sleeve diameter : 50mm.
- Sleeve length : 15"
- Max load capacity 816 kg / 1800 lbs.



## LEGACY 1002

### HEAVY DUTY OLYMPIC BAR

- Net weight : 20 kgs.
- 7.2 ft Olympic length.
- Metal composition EN 8
- Coating : Nickle.
- Comes with 2 bronze bush & 4 high quality bearings.
- Shaft diameter : 30mm.
- Sleeve diameter : 50mm.
- Sleeve length : 15".
- Max load capacity 816 kg / 1800 lbs.



## IR94039

### HEAVY DUTY OLYMPIC BAR

- Net weight : 20 kgs.
- 7.2 ft olympic length.
- Made from carbon steel.
- High quality nickel chrome finish.
- Shaft diameter : 30mm.
- Sleeve diameter : 50mm.
- Sleeve length : 14".
- Max. load capacity : 816 kg / 1800 Lbs.



## IR94038

### OLYMPIC BAR

- Net weight : 16 kgs.
- 7.2 ft olympic length.
- Made from carbon steel.
- High quality nickel chrome finish.
- Shaft diameter : 28mm.
- Sleeve diameter : 50mm.
- Sleeve length : 14".



## IR94052

### 72" OLYMPIC BAR

- Net weight : 13 kgs.
- High quality nickel chrome finish.
- Shaft diameter : 28mm.
- Sleeve diameter : 50mm.
- Sleeve length : 11".



## IR94051

### 60" OLYMPIC BAR

- Net weight : 11 kgs.
- High quality nickel chrome finish.
- Shaft diameter : 28mm.
- Sleeve diameter : 50mm.
- Sleeve length : 10".



## IR94048

### 48" OLYMPIC BAR

- Net weight : 10 kgs.
- High quality nickel chrome finish.
- Shaft diameter : 28mm.
- Sleeve diameter : 50mm.
- Sleeve length : 8".



## IR94047

### 47" EZ CURL BAR

- Net weight : 10 kgs.
- High quality nickel chrome finish.
- Shaft diameter : 28mm.
- Sleeve diameter : 50mm.
- Sleeve length : 8".



## IR102

### MULTI GRIP BAR

- Size : 2.2 meter



## IR94083

### 56" OLYMPIC BAR



## IR94025

### 14" REGULAR RUBBER HANDLE HOLLOW BAR

- Matches our small hole rubber plates



## IR94045

### OB20" OLYMPIC BAR



## IR94046

### OLYMPIC TRICEP BAR



**IR94061**

COLLAR



**IR94064**

OLYMPIC BAR COLLAR (PLASTIC)



**IR94065**

OLYMPIC BAR COLLAR (TPR)



**IR95069**

NYLON LAT ROPE



**IR95070**

SINGLE GRIP NYLON LAT BAR



**IR95071**

TRICEP ROPE 70 CMS



**IR95017**

38" SOLID LAT BAR



**IR95015**

48" SOLID LAT BAR



**IR95021**



**IR95020**

20" SOLID LAT BAR



**IR95023**



**IR95022**



**IR95025**



**IR95019**



**IR95029**



**IR95028**



**IR107**

**SPIRAL TRICEP ROPE**



**IR95024**



**IR95026**



**IR108**

**SAFETY SQUAT BAR**



**IR94089**

**OLYMPIC BAR PIVOT**



**IR94090**

**T BAR HANDLE**



## IR103

### ROPE TRAINER

- Unique cardio workout
- Adjustable resistance control



## IR104

### FLY WHEEL ROPE TRAINER

- Unique cardio workout
- Adjustable resistance control



## IR110

### DEADLIFT MINI JACK



## IR111

### DOUBLE DEADLIFT JACK



## IR112

### SQUAT WEDGE 20°



## IR113

### WEIGHT STACK PIN

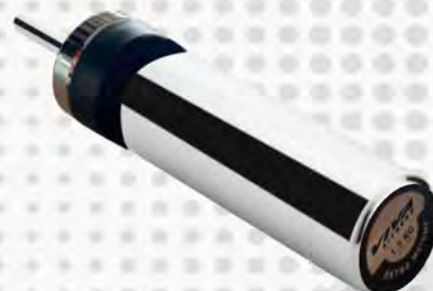

**IR115**

OB HAND GRIP BAR



**IR116**

REVOLVING HANDLE GRIP



**IR117**

CABLE ATTACHMENT



**IR118**

PULL DOWN HANDLE ATTACHMENT



**IR119**

WEIGHT LIFTING GRIP



**IR120**

STRAP HANDLE



**IR121**

**HANDLE GRIP**



**IR122**

**HANDLE ACCESSORY**



**WOODEN PEG BOARD**



**CLUB BAR**



**AVAILABLE SIZES**

**KGS**

2

4

6

8

10

12

15

20

## POUND PAD

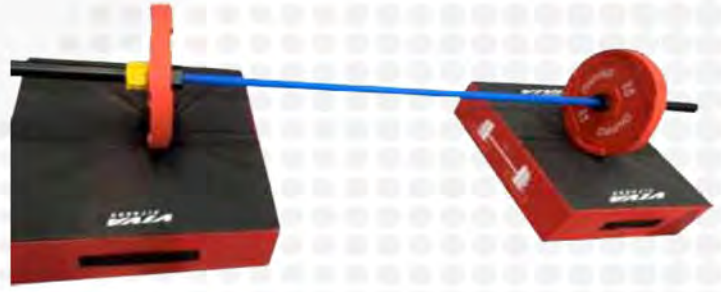

## WOODEN DECK WITH CRASH PADS



## MAG HANDLE SET OF 5



## MAG HANDLE PRO BUNDLE SET OF 8



## SLED WITH TYRES



## POWER SLED

- Heavy metal Construction with Shoulder Harness
- Good for all Push Pull
- Drag Sports & Speed Training
- Dual side operational



## WEIGHT SLED HYPER PRO

- Heavy metal Construction with Shoulder Harness
- Good for all Push Pull
- Drag Sports & Speed Training



## FLIP TYRE

- Large Dia tyre made from pre-used rubber
- Develops Power and Strength
- Good for Functional Training
- FTU100 (100 kgs.)
- FTU70 (70 kgs)
- FTU50 (50 kgs)







# OUR CLIENTS...



**WE DESIGN YOUR FITNESS PROJECT**



## **GYM DESIGN**

Our in-house professional design team create gym layout and propose interior schemes to maximise your investment potential in terms of user demand and diversity. Making the best use of available space and incorporating natural features, branding and equipment selection, these are visualized 2D and 3D format with full 3D-rendered animations also available.

## **A COMPLETE SOLUTION**

With more than 16 years experience of running of our own gyms plus unrivalled business planning, operational and management experience, Viva Fitness has the know-how to plan & budget your project along with the hands-on management, qualified expertise and staffing resources to partner you every step of the way towards your ultimate success.



SCAN FOR DOWNLOADING  
THE COMPLETE CATALOGUE

# VIVA FITNESS

P U S H Y O U R S E L F



CELEBRATING  
**50**  
YEARS  
OF EXCELLENCE

MARKETED IN INDIA BY :

**Soccer International Private Limited**

[www.vivafitness.net](http://www.vivafitness.net) [www.tunturiindia.com](http://www.tunturiindia.com) [www.californiafitness.in](http://www.californiafitness.in) [www.bodysolid.com](http://www.bodysolid.com)

\* All pictures / models are indicative only \* Design and price is subject to change without prior notice \* Conditions apply \* GST extra